

**EPSON**

Color Digital Camera

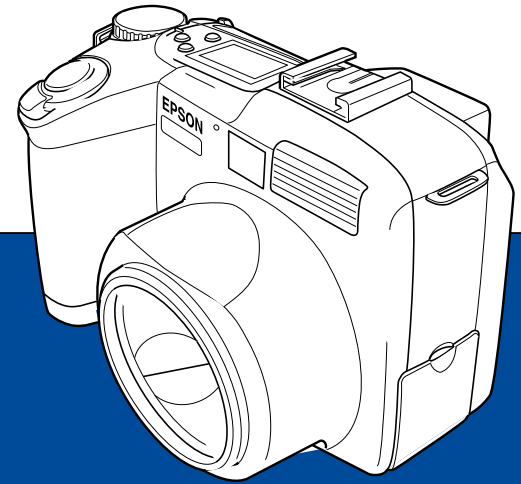

**PhotoPC** 850Z  
*User's Guide*

# Where to Find Information

## ***This User's Guide***

Provides detailed information on using your EPSON PhotoPC 850Z, the Direct Print program, Print Mark program, and optional products; from setting up to troubleshooting.

## ***EPSON Photo!3/EPSON Photo File Uploader3 User's Guide***

Provides information on EPSON Photo!3 software which is necessary for using the photos on your computer, and uploading utilities including EPSON Photo File Uploader3.

## ***Online Help***

Provides detailed information and instructions for EPSON Photo!3 that controls your PhotoPC 850Z. Online help is installed automatically when you install EPSON Photo!3. See the *EPSON Photo!3 User's Guide* for information on accessing online help.

## ***Color Guide (included in the CD-ROM in some locations)***

Explains the basics of color imaging and shows you how to get the most from your PhotoPC 850Z and other EPSON products. See "Viewing the Color Guide" on page 2-34 of this *User's Guide* for information on accessing the *Color Guide*.

**EPSON®**

***PhotoPC* 850Z**

COLOR DIGITAL CAMERA



Printed on Recycled Paper.

## IMPORTANT NOTICE

All rights reserved. No part of this publication may be reproduced, stored in a retrieval system, or transmitted in any form or by any means, electronic, mechanical, photocopying, recording, or otherwise, without the prior written permission of SEIKO EPSON CORPORATION. No patent liability is assumed with respect to the use of the information contained herein. Neither is any liability assumed for damages resulting from the use of the information contained herein.

Neither SEIKO EPSON CORPORATION nor its affiliates shall be liable to the purchaser of this product or third parties for damages, losses, costs, or expenses incurred by the purchaser or third parties as a result of: accident, misuse, or abuse of this product or unauthorized modifications, repairs, or alterations to this product, or (excluding the U.S.) failure to strictly comply with SEIKO EPSON CORPORATION's operating and maintenance instructions.

SEIKO EPSON CORPORATION shall not be liable against any damages or problems arising from the use of any options or any consumable products other than those designated as Original EPSON Products or EPSON Approved Products by SEIKO EPSON CORPORATION.

EPSON is a registered trademark of SEIKO EPSON CORPORATION. PhotoPC is a trademark of SEIKO EPSON CORPORATION. Macintosh is a registered trademark of Apple Computer, Inc. Microsoft and Windows are registered trademarks of Microsoft Corporation. CompactFlash is a trademark of SanDisk Corporation and has been licensed to CFA (CompactFlash Association).

*General Notice: Other product names used herein are for identification purposes only and may be trademarks of their respective owners. EPSON disclaims any and all rights in those marks.*

Copyright©1999 by SEIKO EPSON CORPORATION, Nagano, Japan.

## Declaration of Conformity

According to ISO/IEC Guide 22 and EN 45014

Manufacturer: SEIKO EPSON CORPORATION  
Address: 3-5, Owa 3-chome, Suwa-shi,  
Nagano-ken 392-8502 Japan  
Representative: EPSON EUROPE B.V.  
Address: Prof. J. H. Bavincklaan 5 1183 AT Amstelveen  
The Netherlands

Declares that the Product:

Product Name: Digital Still Camera  
Model: G770A

Conforms to the following Directive(s) and Norm(s):

Directive 89/336/EEC:  
EN 55022 Class B  
EN 50082-1  
IEC 801-2  
IEC 801-3  
IEC 801-4

September, 1999

H. Horiuchi  
President of EPSON EUROPE B.V.

## A NOTE CONCERNING RESPONSIBLE USE OF COPYRIGHTED MATERIALS

Like photocopiers, digital cameras can be misused by improper photographing of copyrighted material. Unless you have the advice of a knowledgeable attorney, be responsible and respectful by obtaining the permission of the copyright holder before photographing published material.

---

# Contents

## **Introduction**

---

PhotoPC 850Z Features . . . . .	1
Options. . . . .	2
For United Kingdom users - use of options . . . . .	3
Safety Instructions . . . . .	3
When using the camera . . . . .	3
When using the strap . . . . .	4
When using the charger and batteries. . . . .	4
Warnings, Cautions, and Notes . . . . .	7

## **Chapter 1 Getting Started**

---

Unpacking Your PhotoPC 850Z . . . . .	1-1
Camera Parts . . . . .	1-2
Using the Batteries . . . . .	1-4
Charging the batteries . . . . .	1-5
Installing the batteries . . . . .	1-6
Replacing the batteries. . . . .	1-8
Handling the batteries . . . . .	1-8
Storing the batteries . . . . .	1-9
Disposing of the batteries . . . . .	1-9
Setting Up Your Camera . . . . .	1-10
Attaching the strap to your camera . . . . .	1-10

Installing and removing a CompactFlash Card . . . . .	1-10
Setting the language . . . . .	1-11
Setting the date and time . . . . .	1-12

## **Chapter 2 Taking Pictures**

---

Getting Ready . . . . .	2-1
Your camera's picture-taking range . . . . .	2-1
Checking the display panel . . . . .	2-2
Using the dial switch . . . . .	2-3
Making basic settings . . . . .	2-4
Taking Pictures Using the Viewfinder . . . . .	2-5
Using the optical zoom feature . . . . .	2-6
Using the self timer . . . . .	2-6
Making Settings in the Viewfinder Dial Position . . . . .	2-7
Adjusting the image quality . . . . .	2-7
Setting the flash . . . . .	2-9
Adjusting the sensitivity setting . . . . .	2-10
Adjusting the white balance setting . . . . .	2-10
Adjusting the exposure setting . . . . .	2-11
Taking Pictures Using the LCD monitor . . . . .	2-11
Using the basic playback feature . . . . .	2-13
Using the digital zoom feature . . . . .	2-13

Using the macro setting to take close-ups . . . . .	2-14
Taking panoramas . . . . .	2-14
Making Settings in the LCD Monitor Dial Position . . .	2-15
Making predefined exposure settings . . . . .	2-15
Adjusting the white balance setting . . . . .	2-16
Adjusting the sensitivity setting . . . . .	2-17
Making basic exposure adjustments . . . . .	2-18
Making advanced exposure adjustments . . . . .	2-19
Making manual focus settings . . . . .	2-21
Changing the metering system . . . . .	2-22
Taking Multiple Exposures . . . . .	2-23
Using the continuous shooting feature . . . . .	2-23
Using the time lapse feature . . . . .	2-24
Making Audio Recordings for Photos . . . . .	2-25
Right after taking photos . . . . .	2-25
For existing photos . . . . .	2-26
Playback with the built-in speaker . . . . .	2-27
Making Additional Settings . . . . .	2-27
Setting the time and date . . . . .	2-27
Making camera mode settings . . . . .	2-28
Quick shooting feature . . . . .	2-29
Setting the automatic shut-off feature . . . . .	2-30
Setting the LCD monitor's brightness . . . . .	2-31
Adjusting the speaker volume . . . . .	2-31
Setting the beep . . . . .	2-31
Selecting slow synchro timing . . . . .	2-32
Selecting the internal or external flash . . . . .	2-32
Changing the color/monochrome setting . . . . .	2-33
Making user settings for white balance . . . . .	2-33

Selecting the signal system and language . . . . .	2-34
Selecting a folder in the CompactFlash Card . . . . .	2-34
Viewing the Color Guide . . . . .	2-34

---

### ***Chapter 3 Viewing and Managing Your Photos***

Viewing Photos with the LCD Monitor . . . . .	3-1
Displaying multiple photos . . . . .	3-1
Magnifying photos . . . . .	3-2
Viewing a slide show of your photos . . . . .	3-3
Viewing photo information . . . . .	3-5
Managing Photos with the LCD Monitor . . . . .	3-5
Erasing photos . . . . .	3-5
Locking and unlocking photos . . . . .	3-7
Erasing audio recordings . . . . .	3-8
Using Your Computer . . . . .	3-9
Viewing Pictures on a Television . . . . .	3-9
Viewing Pictures with an EPSON Projector . . . . .	3-11

---

### ***Chapter 4 Using Direct Print to Print Photos***

Features . . . . .	4-1
Requirements . . . . .	4-2
Connecting your camera to the printer . . . . .	4-3
Installing the Direct Print Program . . . . .	4-4
Printing Your Images . . . . .	4-4
Accessing the Direct Print program . . . . .	4-4
Choosing a print format . . . . .	4-5

Printing procedures . . . . .	4-7
Printing the photos. . . . .	4-9
LCD Monitor and Display Panel Messages . . . . .	4-10
Printed Image Dimensions . . . . .	4-11

---

### **Chapter 5 Using Print Mark to Print Photos**

---

Features . . . . .	5-1
Installing the Print Mark Program. . . . .	5-2
Making the DPOF File. . . . .	5-2
Printing photos in a standard layout. . . . .	5-2
Printing an index of photos . . . . .	5-4
Confirming and Changing the DPOF File . . . . .	5-6
Deleting the DPOF File . . . . .	5-7
LCD Monitor Messages. . . . .	5-7

---

### **Chapter 6 Camera Options and Accessories**

---

Using Memory Cards. . . . .	6-1
Installing a memory card into your computer. . . . .	6-2
Copying photos directly to a computer . . . . .	6-3
Copying or deleting programs using a memory card . . . . .	6-3
Formatting memory cards . . . . .	6-4
Using the AC Adapter. . . . .	6-5
Using the Lens Adapter. . . . .	6-7

---

### **Chapter 7 Maintenance and Troubleshooting**

---

Maintenance. . . . .	7-1
Handling the camera . . . . .	7-1
Cleaning the camera . . . . .	7-2
Storing the camera . . . . .	7-2
Cleaning the battery charger . . . . .	7-2
Problems and Solutions . . . . .	7-3
Camera problems . . . . .	7-3
Picture problems . . . . .	7-7

---

### **Appendix A Specifications**

---

Camera . . . . .	A-1
Physical dimensions . . . . .	A-1
Product type. . . . .	A-1
Recorded image. . . . .	A-2
Optical. . . . .	A-2
Functional. . . . .	A-3
Interface . . . . .	A-3
Power . . . . .	A-4
CompactFlash Card . . . . .	A-5
Optional PCMCIA Adapter . . . . .	A-5
Optional AC Adapter . . . . .	A-5

## **Appendix B Contacting Customer Support**

---

## **Index**

---

For United Kingdom and the Republic of Ireland Users	B-1
Support Via the World Wide Web . . . . .	B-1
Support Via Telephone . . . . .	B-2
Pre Sales Enquiry Desk . . . . .	B-2
For Australian Users . . . . .	B-3
EPSON FAXBACK. . . . .	B-3
EPSON Bulletin Board System. . . . .	B-3
Internet URL <a href="http://www.epson.com.au">http://www.epson.com.au</a> . . . . .	B-3
Your dealer . . . . .	B-3
EPSON Helpdesk. . . . .	B-3
For Singapore Users. . . . .	B-4
For Hong Kong Users . . . . .	B-4
Internet home page . . . . .	B-4
Electronic bulletin board system . . . . .	B-5
Technical Support Hotline . . . . .	B-5
For Philippines Users . . . . .	B-5

## **Appendix C Dial Position Settings**

---

Available settings in the dial position. . . . .	C-2
Available settings in the dial position. . . . .	C-3
Available settings in the dial position. . . . .	C-3
When using the Program camera mode. . . . .	C-3
When using the Manual camera mode. . . . .	C-4

## **Glossary**

---



---

# Introduction

Your new EPSON® PhotoPC™ 850Z is a revolutionary, easy-to-use digital camera that enables you to take full-color pictures for use with your computer. The PhotoPC 850Z comes with everything you need, including EPSON Photo!3 software that lets you transfer your pictures to your computer's hard disk. You can then edit, enhance, and organize your pictures, or simply place them into your documents. To use EPSON Photo!3, see the *EPSON Photo!3/EPSON Photo File Uploader3 User's Guide*.

Create professional letters, documents, and presentations with real life images right on your desktop. Share pictures with business colleagues or friends over the Internet. Add color and visual appeal to your newsletters, flyers, and brochures. Anything you can print out or display on your screen will look better with images from your PhotoPC 850Z.

---

## PhotoPC 850Z Features

PhotoPC 850Z is a complete system for capturing digital images, and includes the following features.

- ❑ 2.1 Mega pixel CCD (can be enhanced to 3.0 Mega pixel with HyPict)
- ❑ 24-bit color image capture
- ❑ High resolution (1600×1200 pixels, or 1984×1488 pixels with HyPict)
- ❑ Built-in color LCD monitor for previewing and playing back pictures
- ❑ Built-in microphone and speaker for audio recordings and playback
- ❑ Macro and panorama photo formats
- ❑ Optical ×3 and digital ×2 zoom
- ❑ Continuous shooting of up to ten pictures
- ❑ Automatic, predefined, or manual white balance

- ❑ Automatic, predefined and adjustable exposure settings (-2.0 to + 2.0 EV, in increments of 0.5 or 0.2)
- ❑ Automatic date and time recording for each picture
- ❑ Built-in flash with automatic flash, forced flash, flash off, red-eye reduction, and leading or trailing slow synchro flash (for taking pictures at night or in dark places)
- ❑ Built-in hot sync flash shoe for external flash, sold separately, for manual photo shooting (for information, contact your EPSON dealer.)
- ❑ Self timer (ten seconds)
- ❑ Automatic shut-off setting to save batteries
- ❑ EPSON Photo!3 software that lets you transfer your pictures to your computer
- ❑ EPSON Photo File Uploader3 software that allows you to convert images and audio recordings stored in your computer to EPSON Photo file format and upload them to your camera
- ❑ EPSON Program Uploader software that lets you upload optional programs to the camera from your computer
- ❑ Pictures compatible with both Windows® and Macintosh® applications

---

## **Options**

The following PhotoPC 850Z options are available from EPSON.

- ❑ CompactFlash™ Card  
(For information, contact your EPSON dealer.)
- ❑ PCMCIA adapter (B867041)
- ❑ AC Adapter (B867081, B67131, B867091, B867101, B867121, B867151, B867111, B867141) for use with a standard electrical outlet
- ❑ Power Pack (B81817\*) which includes:  
Ni-MH Battery Charger  
Four Ni-MH Rechargeable Batteries
- ❑ Package of four Ni-MH Rechargeable Batteries (B81811\*)

**Note:**

- ❑ *The asterisks are substitutes for the respective digits of the product number, which varies by country.*
- ❑ *The PhotoPC 850Z comes with a Power Pack (described above) and an 8 MB CompactFlash Card.*
- ❑ *The AC Adapter model EU-40 and Battery Charger model EU-38 conform to CE marking requirements in accordance with EC Directives 73/23/EEC and 89/336/EEC.*

**For United Kingdom users - use of options**

EPSON (UK) LTD shall not be liable against any damages or problems arising from the use of any options or consumable products other than those designated as Original EPSON Products or EPSON Approved Products by EPSON (UK) LTD.

---

**Safety Instructions**

Read all these instructions and save them for later reference. Follow all warnings and instructions marked on the camera and options.

**When using the camera**

- ❑ To reduce the risk of electric shock, do not remove the cover of the camera or options and do not open any compartments except as instructed in this *User's Guide*.
- ❑ Do not insert objects into any openings.
- ❑ To prevent fire or electric shock, do not expose the camera or options to rain or moisture.
- ❑ To prevent fire or electric shock, do not cover the camera with a blanket.
- ❑ To prevent fire or explosion, do not use the camera where flammable or volatile gas is stored.
- ❑ Do not use outdoors during a thunderstorm.
- ❑ If the camera or option shows unusual signs such as noise, odor, or smoke, stop usage and turn off immediately. Remove the batteries and/or disconnect the AC adapter from the camera, and unplug the AC adapter from the electrical outlet.
- ❑ To prevent possible injury, do not take flash pictures close to the subject's eyes.
- ❑ Use only the type of power source indicated in this *User's Guide*.

- ❑ Do not use damaged or frayed power cords.
- ❑ Remove the batteries and/or plug from the camera and refer servicing to qualified service personnel in the following circumstances:

The power cord or plug is damaged; liquid has entered the camera or options; the camera or options have been dropped or the case damaged; the camera or options do not operate normally or exhibit a distinct change in performance.

- ❑ Never adjust controls that are not mentioned in the operating instructions.
- ❑ If you plan to use the camera and options in Germany, observe the following:

To provide adequate short-circuit protection and over-current protection for the products, the building installation must be protected by a 16 Amp circuit breaker.

Bei Anschluß des Produkts an die Stromversorgung muß sichergestellt werden, daß die Gebäudeinstallation mit einem 16 A-Überstromschalter abgesichert ist.

- ❑ If the liquid crystal solution contained in the display panel or in the screen on the LCD monitor leaks out and gets on your hands, wash them thoroughly with soap and water. If it gets into your eyes, flush them immediately with water.

### ***When using the strap***

- ❑ Do not swing the camera about. This can damage the camera or other objects, or injure others.
- ❑ Do not pull or tighten the strap too firmly while wearing it around your body; this can cause serious injury.
- ❑ Keep the strap away from children.

### ***When using the charger and batteries***

- ❑ Read all relevant safety and operating instructions before using these products.
- ❑ Use only the EPSON Ni-MH Battery Charger, Model EU-38 to charge the EPSON Ni-MH Batteries Model EU-24. Never attempt to charge other types of batteries in this charger as they may explode, leak, overheat, or cause personal injury.

- ❑ Do not charge primary (non-rechargeable) batteries.
- ❑ Use the type of power source indicated on the charger's label. Always supply power directly from a standard domestic electrical outlet.
- ❑ Be sure your AC power cord meets relevant safety standards of the area where you plan to use it.
- ❑ Do not use the batteries or charger near water or handle them with wet hands.
- ❑ Unplug the charger if the batteries are not fully charged after four hours.
- ❑ Power-supply cords should be protected from abrasion, cuts, crimping and kinking. Be sure to place your cords to avoid any damage. Do not place objects on top of the power cord or allow the power cord to be stepped on or run over. You should take special care to try to keep the power cord straight at the ends and the points where it enters and leaves the transformer.
- ❑ Unplug your equipment from the wall outlet and refer servicing to qualified personnel under the following conditions:

If the power cord or plug is damaged; if liquid has entered your equipment; if your equipment has been exposed to rain or water; if your equipment has been dropped or damaged; if your equipment is operating abnormally or exhibits a distinct change in performance. Adjust only those controls described in your product documentation.

- ❑ Do not attempt to service the charger yourself. Refer all servicing to qualified service personnel.
- ❑ Keep away from heat sources. Use the charger within the temperature range of 5°C to 35°C (41°F to 95°F).
- ❑ Do not insert batteries into the charger backward as they may explode, leak, overheat, or cause personal injury.
- ❑ Do not insert objects into any openings as they may touch dangerous voltage points or short out parts.
- ❑ Never disassemble or modify the charger.
- ❑ Use charger in a dry, indoor location.
- ❑ Do not expose batteries or the charger to water or high humidity.

- ❑ Keep the charger out of reach of children.
- ❑ Only use the batteries in EPSON Digital Cameras as specified in this manual.
- ❑ Never use EPSON Ni-MH batteries in combination with any other type of batteries.
- ❑ To guard against short-circuiting, do not remove the outside sleeves of the batteries.
- ❑ Beware of electrical shock hazard.
- ❑ If battery acid gets into your eyes or on your skin, immediately rinse the affected area thoroughly with water and seek medical treatment. If a battery is swallowed, seek medical treatment immediately.
- ❑ Never use EPSON Ni-MH batteries in combination with any other type of batteries, and always use batteries from the same package as a set. Do not mix old and new batteries, or charged and discharged batteries.
- ❑ Do not use manganese batteries (IEC R6).
- ❑ Keep the batteries from making contact with metal objects such as coins or keys, which could short circuit the batteries.
- ❑ Do not drop, puncture, disassemble, mutilate, or short circuit batteries. Do not put the batteries near or into fire or water.
- ❑ Do not insert batteries into wall outlets or other power sources such as a car cigarette lighter socket.
- ❑ Do not solder lead wires or terminals directly to a battery.
- ❑ To avoid fire or electric shock, do not use batteries that are leaking or damaged in any way.
- ❑ To prevent fire or electric shock, do not cover the charger with a blanket.
- ❑ To prevent fire or explosion, do not use the charger where flammable or volatile gas is stored.

---

## **Warnings, Cautions, and Notes**



*Warnings must be followed carefully to avoid bodily injury.*



*Cautions must be observed to avoid damage to your equipment.*

*Notes contain important information and useful tips on the operation of your camera and options.*





This chapter helps you prepare your PhotoPC 850Z and covers the following topics.

- Unpacking your PhotoPC 850Z
- Getting familiar with camera parts
- Charging, installing and replacing batteries
- Attaching the strap
- Installing the CompactFlash Card
- Setting your language, date, and time for your camera

**Unpacking Your PhotoPC 850Z**

Make sure you have everything shown below.

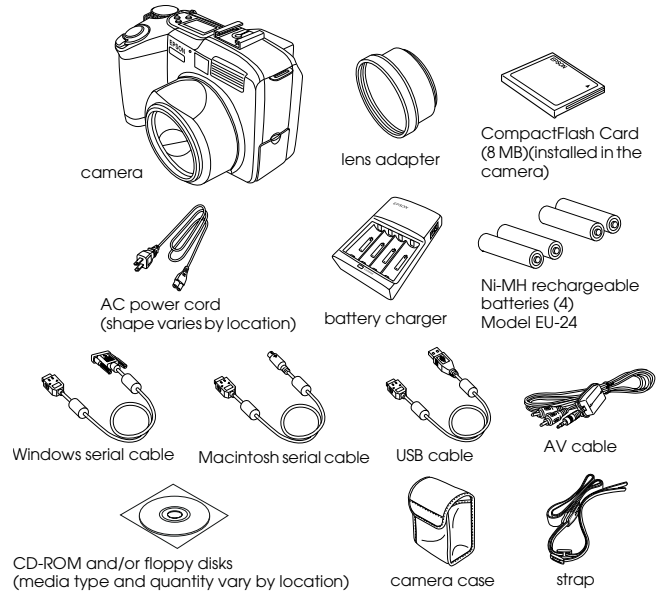

## Camera Parts

After you unpack your PhotoPC 850Z, take a few minutes to learn about its features as shown below.

### Front view

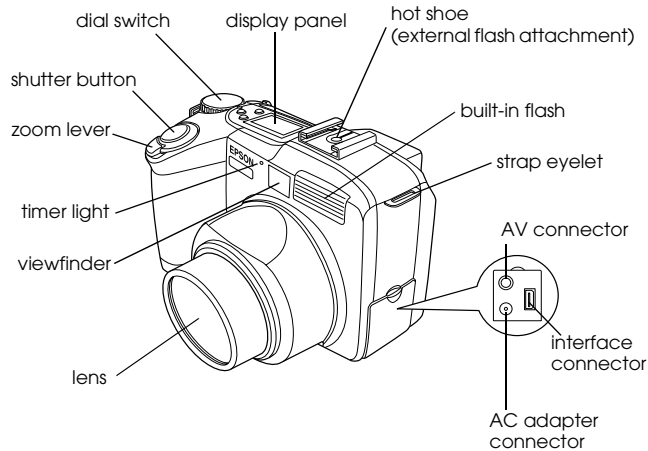

### Back view

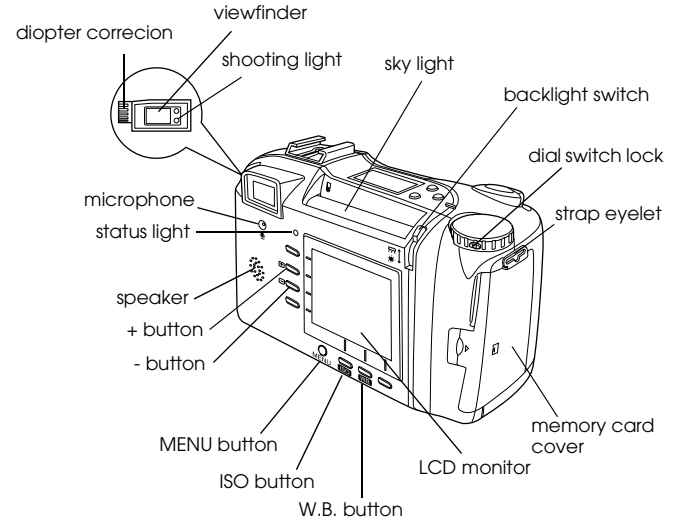

### Note:

*In this user's guide, the buttons are sometimes named after the corresponding indications on the LCD monitor.*



### Warning:

*The speaker uses a magnet. Keep important magnetic objects, such as credit cards and floppy disks, away from the speaker. EPSON shall not be liable for any damages or lost information.*

Bottom view

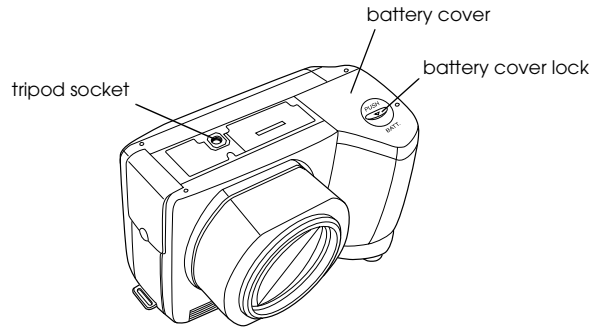

Top view

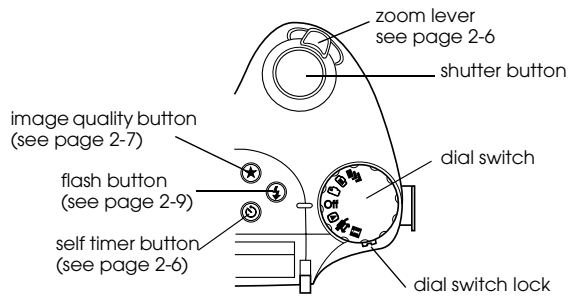

Display panel

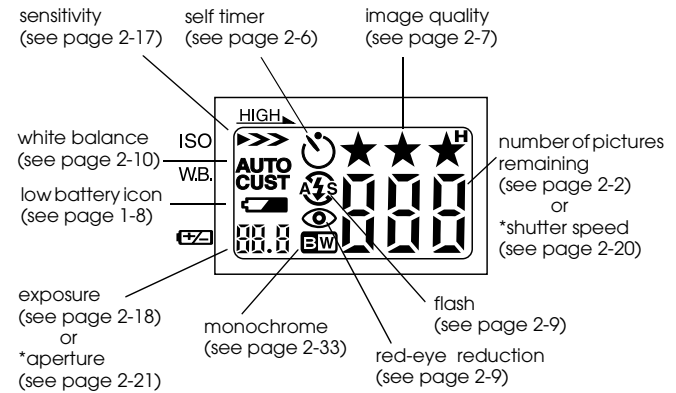

\* When shutter is pressed half-way and Program or Manual camera mode is selected.

Shooting and status lights

The camera has the shooting lights beside the viewfinder and the status light beside the LCD monitor. They turn on or blink in color to indicate the shooting conditions and current status of the camera.

## Shooting light

Color	Shooting status
Green (On)	Ready for shooting Viewing photos AC adapter connected
Green (Blinking)	Transferring photo images
Red (Blinking)	Memory card not installed Full memory card Low battery
Red (On)	Error. Contact your EPSON dealer for service.

## Status light

Color	Camera's status
Green (On)	Ready for shooting Locking focus
Green (Blinking)	Power on Focusing Charging flash

---

## Using the Batteries

Your PhotoPC 850Z comes with four Ni-MH rechargeable batteries (Model EU-24) and the Ni-MH Battery Charger (Model EU-38). Though you can use four AA (IEC LR6) alkaline batteries (not included), the rechargeable batteries help you save time and money you might otherwise spend buying replacement alkaline batteries. Be sure to charge your new rechargeable batteries before installing them in the camera.

**Note:**

*Do not use manganese batteries (IEC R6).*

Keep the following points in mind when using these batteries.

- ❑ To fully charge new batteries or batteries that have not been used for a long time, you may have to charge them two or three times.
- ❑ Use batteries regularly so that they continue to charge well. Batteries which have not been used for a long time will return to normal with regular use.

- ❑ Discharge batteries completely before recharging them. If your batteries are not completely drained of power, you may not be able to recharge them fully.
- ❑ Batteries charged in a hot environment wear out more quickly.
- ❑ Do not leave batteries in the camera or charger for a long time without use. See “Storing the batteries” on page 1-9 for storage instructions.
- ❑ Rechargeable batteries wear out with repeated use; as their charging capacity decreases, your camera’s operating time decreases. Replace the batteries when their operation time becomes short.

## Charging the batteries

The Ni-MH Battery Charger charges your Ni-MH rechargeable batteries quickly to last longer in your camera.

When you use alkaline batteries, see “Installing the batteries” on page 1-6

Before charging your batteries, be sure to read the safety instructions in “When using the charger and batteries” on page 4.



### Warning:

- ❑ Do not charge batteries other than the Ni-MH rechargeable batteries (Model EU-24).
- ❑ Do not mix different types of batteries; this can cause fire or explosion.
- ❑ Always use batteries from the same package as a set. Do not mix old and new batteries.

Follow these steps to charge your Ni-MH batteries.

1. Install the batteries into the compartments, positioning the + and - ends as shown.



### Caution:

Install and charge four batteries at a time for your camera.

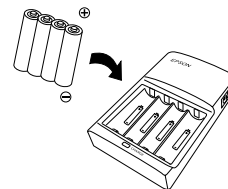

2. Connect the battery charger to the power cord as shown below.

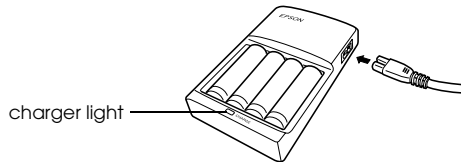

3. Plug the charger into an electrical outlet. The charger light turns red indicating that the charger is working.



**Caution:**

*Be sure to insert all plugs and connectors firmly and completely.*

4. When the batteries are fully charged, the light goes off. To charge your batteries again, unplug the AC power cord, and then plug it in again.

**Note:**

*Replace the batteries with new Ni-MH batteries in the following cases: the charger light stays on for more than 240 minutes or the charger light flashes for more than half an hour.*

5. After the light goes off, unplug the charger. To avoid overcharging, do not leave the charger plugged in for long periods of time after the light goes off.

6. After the batteries cool, remove them from the charger.



**Warning:**

*Batteries are very hot (approximately 65°C) during and just after charging. Wait one hour for the batteries to cool before handling.*

7. Before storing the charger, disconnect the AC power cord and remove the batteries.

## ***Installing the batteries***

Before installing the batteries, be sure to read the safety instructions in “When using the charger and batteries” on page 4.

Make sure the camera is off, and follow these steps to insert or replace the batteries.

1. Turn the camera upside down with the lens facing you. Hold the PUSH button down and slide the battery cover as shown below.

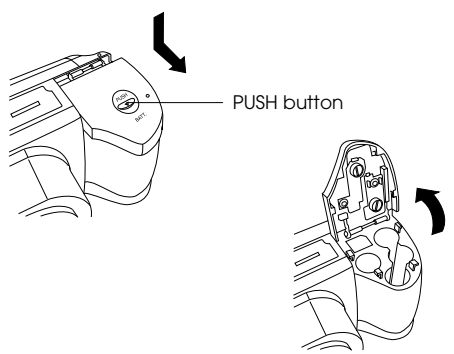

2. Insert four batteries into the compartment, positioning the + and - ends as shown below. Then lower the battery cover.

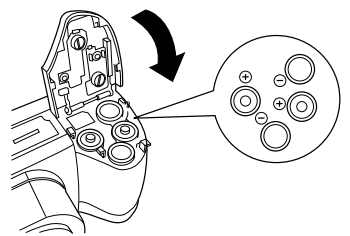

3. Hold the battery cover down and slide it as shown below.

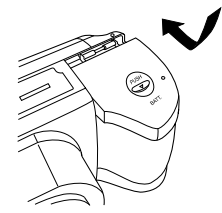

When the battery power is almost out, a low battery icon  appears on the display panel. When the battery power runs out, this icon blinks and the camera automatically turns off. Remove and recharge your batteries, and then install the batteries.

**Note:**  
*While the flash is being charged when the battery level is low, the LCD monitor is turned off. When the charge is complete, it is turned on again.*

## Replacing the batteries

Replace your PhotoPC 850Z batteries when the low battery icon  appears on the camera's display panel. Be sure to replace the four batteries at the same time. You can replace them with any of the following batteries.

Single-use AA (IEC LR6) alkaline batteries

Rechargeable AA Ni-MH batteries

### Note:

- Battery life varies depending on the battery type and the manufacturer.*
- If you use rechargeable Ni-MH batteries in the PhotoPC 850Z, replace them with four fully-charged batteries. If you find that your batteries run out soon after recharging them a number of times, make sure you discharge them completely before recharging.*
- The Ni-MH rechargeable batteries are available as an option.*
- When the low battery icon  appears, you cannot use the following features. They are dimmed on the LCD monitor.*

When you play back photos and audio recordings:

Delete  
Select Image  
Sound

When you make settings:

Quick Shot (only Normal Shot available)  
Language selection icon  Memory SETUP

## Handling the batteries

Keep the battery ends clean by wiping them with a dry cloth.



### Warning:

- Do not apply heat or force to batteries, and do not disassemble, drop, short-circuit, or put batteries into fire or water.*
- Do not keep batteries loose in your pockets.*
- Do not mix different types of batteries; this can cause fire or explosion.*
- Always use batteries from the same package as a set. Do not mix old and new batteries.*



## Storing the batteries

If you do not plan to use the camera for a long period of time, remove the batteries and store them at a low temperature in a dry location.



### Warning:

- Do not store batteries with metal objects, which could short-circuit the batteries.
- Avoid storing batteries in extremely hot or humid locations.
- Store batteries out of reach of children.
- Always remove the batteries from the camera and charger before storing. Batteries left in your camera and charger for a long time may leak and cause damage.

## Disposing of the batteries

Before disposing of batteries, make sure you discharge them completely.



### Warning:

- Be sure to securely cover the + end of each battery with tape to prevent combustion or explosion when disposing.
- Dispose of used batteries according to the manufacturer's instructions and in compliance with all applicable laws. Contact your local government agency for information about battery recycling and disposal.

### For the Netherlands users:

Do not dispose of the batteries with ordinary refuse. Instead, dispose of them as small chemical waste in accordance with local laws, and the following Dutch Government Gazette 45, KCA Marking:



Bij dit produkt zijn batterijen geleverd.  
Wanneer deze leeg zijn, moet u ze niet  
weggoien maar inleveren als KCA.

### For German users:

Do not dispose of batteries with ordinary refuse. Instead, dispose of them in a recycle box in accordance with local laws.

---

## Setting Up Your Camera

This section explains how to attach the strap to your camera, install a memory card, and make a few basic camera settings.

### Attaching the strap to your camera

Before attaching the strap, be sure to read the safety instructions in “When using the strap” on page 4.

To attach the strap, pass the strap through the eyelet on the side of the camera as shown below then pass it through the clamp to fix it.

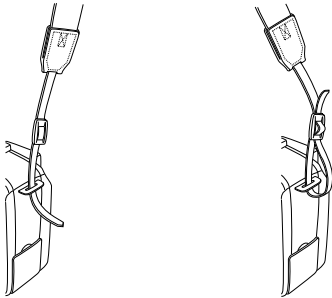

Attach the other end of the strap to the eyelet on the other side of the camera in the same way.

## Installing and removing a CompactFlash Card

You need a CompactFlash Card (from now on — ‘memory card’) to take photos. It has been installed in the camera at shipment. When you need to install it, follow these steps.

1. Make sure the camera’s dial switch is turned to Off.
2. Open the memory card cover. Insert the card all the way into the memory card slot. Make sure the front of the card and the front of the camera are facing the same way.

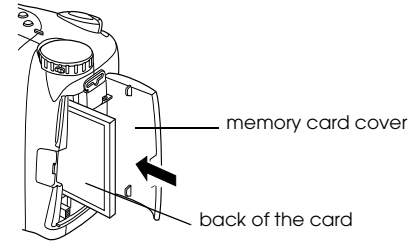

3. Turn up the eject button.

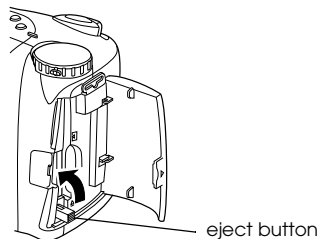

To remove the card, turn down and push the eject button below the memory card slot. Remove the card by hand.

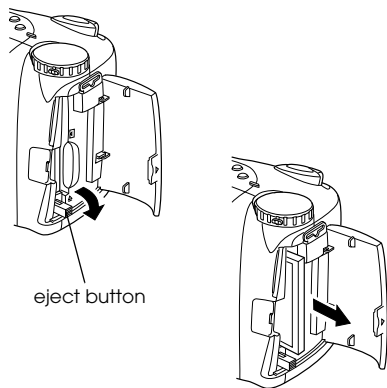

**!** **Caution:**

- ❑ Never remove the card while the camera is on. Data in the card may be lost or damaged.
- ❑ Avoid using or storing the card in direct sunlight, or in places that are extremely hot, humid, or dusty.

4. Close the cover.

### Setting the language

You must select the language for messages displayed on the LCD monitor the first time you use the camera. Depending on the country of purchase, you can choose English, Japanese, French, German, Italian, Portuguese, Spanish, or Chinese.

Follow these steps to set the language.

1. Turn the camera's dial switch to **!**. A message stating that you need to set the language appears on the LCD monitor.
2. Press the ISO, W.B., +, or, -, button to move the cursor to the language you use.
3. Press SET to save your selection.

To change the language setting, see “Selecting the signal system and language” on page 2-34.

Next set the date and time as described in the following section.

## **Setting the date and time**

When you install the batteries for the first time, you need to set the date (month, day, and year) and time (hour and minutes). After you make these settings, the camera automatically records the date and time of each picture.

Follow these steps to set the clock on the LCD monitor.

### **Note:**

*If you connect the PhotoPC 850Z to your computer and access EPSON Photo!3 when the camera's clock is not set, the camera's date and time is set to that of the computer's automatically. For instructions on connecting the camera to the computer and accessing EPSON Photo!3, see the EPSON Photo!3 User's Guide.*

1. Turn the camera's dial switch to . A screen appears with the setting for the month highlighted in red.

2. Press the + or - button to increase or decrease the number until the month is correct.
3. Press the ISO or W.B. button to move through each item and make adjustments as described in the previous step.
4. When the date and time settings are correctly adjusted, press SET to save your selection.

You are now ready to take pictures with your PhotoPC 850Z. Turn to Chapter 2, “Taking Pictures,” for simple, step-by-step instructions.

After taking photos, you can transfer the images to your computer in the following ways:

- ❑ Using your camera along with EPSON Photo!3 software. For software installation instructions, see the *EPSON Photo!3 User's Guide*.
- ❑ By inserting your card into your computer's memory card slot directly or with a PCMCIA adapter. To use the memory card, see “Installing a memory card into your computer” on page 6-2.

Using the PhotoPC 850Z to take pictures is similar to using a traditional “point and shoot” camera. This chapter explains how to take photos with the camera and covers the following topics.

Picture-taking range

Checking the display panel

Making basic settings

Taking different kinds of pictures

Using the advanced settings

Getting tips from the online *Color Guide*

---

### Getting Ready

This section helps you prepare to take pictures with your PhotoPC 850Z. It includes information on your camera’s picture-taking range and explains how to make image quality and flash control settings.

**Note:**

*EPSON is not responsible for any images you may lose while using our products and software. Make sure your camera works normally before taking important pictures.*

### Your camera’s picture-taking range

The camera should be at least 50 centimeters away from the subject when composing a shot through the viewfinder.

Close-up photos can be taken from as close as 20 to 50 centimeters to the subject using the macro feature. For instructions on using this feature, see “Using the macro setting to take close-ups” on page 2-14.

The flash has the following effective range.

Wide: 80-370 centimeters

Tele: 80-260 centimeters

Macro: 20-50 centimeters

The range varies depending on the sensitivity setting. See “Setting the flash” on page 2-9 for more details.

When you are taking pictures outdoors, make sure the sun is behind you. In very bright light (for example, at the beach or in snow), your pictures may come out too light. You can adjust the exposure manually to make your photos brighter or darker. For instructions, see “Making advanced exposure adjustments” on page 2-19. You can also correct these problems with your computer using image editing software.

## Checking the display panel



The large number in the lower right of the display panel shows the remaining amount of pictures you can take.

This number is affected by the image quality setting. When you adjust the image quality, the number of remaining pictures changes accordingly.

When you take photos, you can see the number of remaining photos you can take and the total number of photos you can save in the memory card on the LCD monitor. When you play back photos, the LCD monitor displays the number of the photo you are looking at and the total number of photos you have taken.

### **Note:**

*If there are any audio recordings stored on your memory card, the number on the display panel may be greater than the actual number of remaining pictures.*

When the memory card is full, the number on the display panel reads 0, the shooting light on the back of the camera blinks red, and you are unable to use the shutter button. Before you can take any more pictures, you need to erase some or all of the images in the memory card. See “Erasing photos” on page 3-5 for instructions. If you want to save your photos before you erase them, transfer them to your computer with *EPSON Photo!3* or via the memory card.



When using the quick shooting feature, the number of photos taken and temporarily saved in the camera is displayed in brackets.

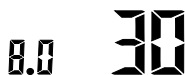

In the Program and Manual camera modes, while holding the shutter button down halfway, the exposure value appears on the left and the shutter speed appears on the right.

**Note:**

When the shutter speed is set to the slowest four seconds, **L** appears on the display panel.



When you turn the camera's dial switch to **Set**, **SEt** is displayed on the display panel.



While making an audio recording, **rEc** appears on the display panel.



When taking photos with the time lapse feature, **Int** appears on the display panel.

## Using the dial switch

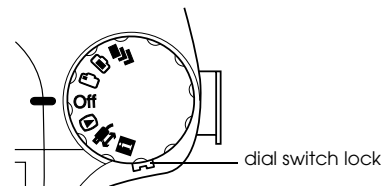

You can turn the camera on by turning its dial switch to one of six different positions. This section gives an overview of when to use each dial position.

**Note:**

To turn the dial switch when the camera is off, you must hold in the dial switch lock.

### Dial positions for taking pictures

When you want to take pictures, turn the dial switch to one of the orange icons on the top of the dial.



For taking multiple exposures. See "Taking Multiple Exposures" on page 2-23 for details.





For taking photos with the LCD monitor. See "Taking Pictures Using the LCD monitor" on page 2-11 for details.

-  For taking pictures with the viewfinder. See “Taking Pictures Using the Viewfinder” on page 2-5 for details.



### **Other dial positions**

To perform other camera operations, turn the dial switch to any of the bottom icons.

-  For playing back and managing photos. See Chapter 3, “Viewing and Managing Your Photos,” for details.
-  For using Direct Print, Print Mark, EPSON Photo!3, and other software. See Chapter 4, “Using Direct Print to Print Photos,” Chapter 5, “Using Print Mark to Print Photos,” and the *EPSON Photo!3 User’s Guide* for details.
-  For viewing information and setting up the camera. See “Making Additional Settings” on page 2-27 for details.

### **Making basic settings**

The three small buttons on top of the camera allow you to make a few basic settings easily. You can make these settings when the camera’s dial switch is set to one of the orange icons.

-  Changes the image quality setting. See “Adjusting the image quality” on page 2-7 for details.
-  Changes the flash setting. See “Setting the flash” on page 2-9 for details.
-  Turns the self timer on and off. See “Using the self timer” on page 2-6 for details.

#### **Note:**

*Using EPSON Photo!3, you can also take photos and make basic settings from a computer to which the PhotoPC 850Z is properly connected. See the EPSON Photo!3 User’s Guide for more details.*



## Taking Pictures Using the Viewfinder

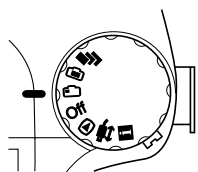

Using the viewfinder instead of the LCD monitor when taking pictures saves battery power and helps you hold the camera steady when pressing the shutter button.

Follow the steps below.

1. Turn the camera's dial switch to . Then wait until the shooting light beside the viewfinder turns green.
2. Look straight through the viewfinder and center your subject in the cross-hairs. If you cannot see clearly, adjust the diopter by turning the correction dial beside the viewfinder.

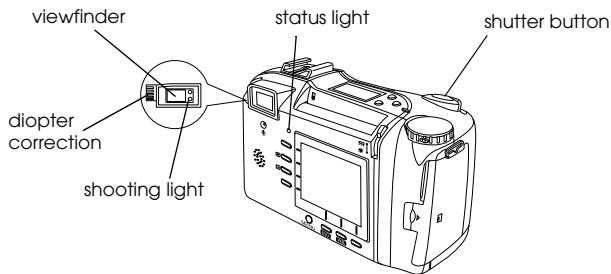

### Note:

- Hold the camera firmly with both hands and keep the posture for a while when you press the shutter button.
  - Make sure you are not blocking the lens with your finger, strap, clothing, or other objects.
  - The frame in the viewfinder indicates the area captured when taking pictures at close range.
3. Hold the shutter button halfway down to lock the auto focus. The shooting light beside the viewfinder stops blinking after the lens locks in focus. If you wish, you can now move your subject off-center without altering the focus.

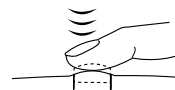

4. Press the shutter button the rest of the way down to take the photo.



5. Hold the camera still until the shooting light beside the viewfinder and the status light above the LCD monitor come back on, or until the camera beeps. Then release the shutter button.

You can take another photo when the shooting light next to the viewfinder stops blinking in green.

After you take a picture, the status light blinks in green. This indicates that the image is captured and the camera is processing it. When the light stops blinking, the image is saved. Saved images remain in the memory card even when the camera is turned off, the batteries are removed, or the memory card is removed from the camera.

## ***Using the optical zoom feature***

Turn the zoom lever at the shutter button. You can use the optical zoom feature at any time.

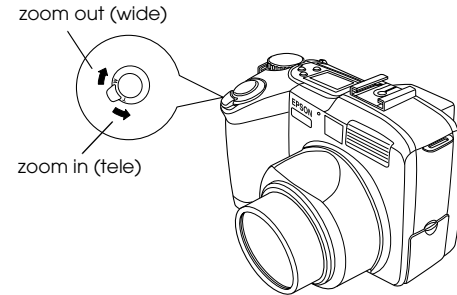

## ***Using the self timer***

 Turning on the self timer creates a 10-second delay between the time you press the shutter button and the moment the actual image is captured, allowing you to take pictures of yourself. The timer icon appears on the display panel when you turn on the timer. Follow the steps below.

1. Secure the camera on a flat surface or a tripod.
2. Turn the camera's dial switch to . Then wait until the shooting and status lights turn green.

3. Press the  timer button on the top of the camera. The timer icon appears on the display panel.
4. Press the shutter button. The timer icon and the red timer light on the front of the camera flash slowly for eight seconds, then rapidly for two seconds before the shutter releases.

To take another picture using the self timer, you need to press the  timer button again.

**Note:**

- ❑ *To stop the self timer after pressing the shutter button, press the shutter button again, or press the  timer button.*
- ❑ *You can also use the self timer with the continuous shooting feature. The camera takes up to ten pictures in sequence, ten seconds after you press the shutter button. To turn continuous shooting on, see "Using the continuous shooting feature" on page 2-23.*

---

## Making Settings in the Viewfinder Dial Position

You can use camera buttons to make a variety of settings when taking pictures with the viewfinder. This section explains how to make these settings.

### Adjusting the image quality

The PhotoPC 850Z has four image quality settings. Press the image quality button  on the camera to cycle from one setting to another. You can see the currently selected image quality setting on the display panel or LCD monitor. You can always switch freely between these settings and mix pictures of varying quality in the camera. The memory card's image capacity will vary accordingly.

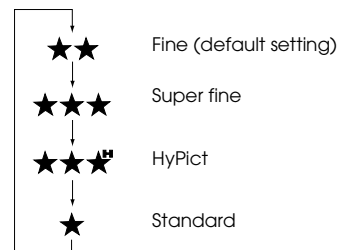



### **Standard**

Images are captured at 640 × 480 pixels. The camera holds approximately 120 pictures without audio recordings in attached 8 MB Compact Flash memory card and the images are less detailed.



### **Fine**

Images are captured in color at 1600 × 1200 pixels. These pictures have moderate detail and approximately 24 pictures can be stored in the included 8 MB CompactFlash Card.



### **Super fine**

Images are captured in color at 1600 × 1200 pixels. These pictures have great detail and approximately 12 pictures can be stored in the included 8 MB CompactFlash Card.



### **HyPict**

Images are captured in color at 1984 × 1488 pixels. These pictures have the greatest detail and approximately ten pictures can be stored in the included 8 MB CompactFlash Card.

### **Note:**

- ❑ *After you take a picture using the HyPict setting, the camera takes approximately 10 seconds to process an image to the memory card.*
- ❑ *HyPict is not available when using the continuous shooting features.*
- ❑ *When using the HyPict image quality setting, you cannot use the quick shooting feature or make audio recordings.*
- ❑ *The Standard image quality setting is not available when taking panoramas and monochrome pictures.*
- ❑ *When the camera is turned off, the image quality setting does not change.*
- ❑ *The number of pictures you can take varies depending on the complexity of the photo you take and the amount of audio recording files saved in the memory card.*

## Setting the flash

The flash has the following effective range.

Wide: 80-370 centimeters

Tele: 80-260 centimeters

Macro: 20-50 centimeters

The range varies depending on the sensitivity setting (see page A-2 for details).

Turn on the camera and press the flash  button on the camera to cycle through the flash settings. The settings appear on the display panel as shown below.

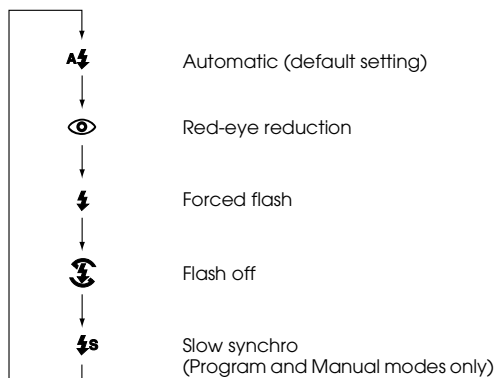

### Automatic

The flash fires automatically whenever more lighting is needed.



### Red-eye reduction

The flash flickers briefly before firing to reduce red eye in flash photos of people. As with the Automatic setting, the flash fires automatically whenever it's needed for adequate lighting.



### Forced flash

The flash fires with every picture you take. Use this setting to compensate for backlighting; for example, when you are facing the sun.



### Flash off

The flash is disabled even when adequate lighting is not available. Use this setting for special effects or when flash is prohibited.



### Slow synchro

The camera's shutter speed slows to enhance the clarity of background details in the shot with object when taking pictures at dawn or twilight, or in places with an illuminated background.

**Note:**

- ❑ After turning on the camera and taking a flash photo, the flash icon blinks and the shooting light beside the viewfinder blinks green until the flash is fully recharged.
- ❑ When you use the external flash, the internal flash is disabled and the  button does not work.
- ❑ Slow synchro is only available in the Program or Manual camera modes. To change the camera mode, see “Making camera mode settings” on page 2-28.
- ❑ You can select the leading or trailing slow synchro. To select the slow synchro, see “Selecting slow synchro timing” on page 2-32.
- ❑ When using the quick shooting function, slow synchro is disabled.

## **Adjusting the sensitivity setting**

When taking pictures with the viewfinder, you can use the camera’s ISO button to change the sensitivity setting. The arrow icons in the display panel next to the ISO mark change accordingly.

**Note:**

You cannot change settings as described above when in the Full Auto camera mode. To change the camera mode, see “Making camera mode settings” on page 2-28.

For details on making sensitivity adjustments, see “Adjusting the sensitivity setting” on page 2-17.

## **Adjusting the white balance setting**

When taking pictures with the viewfinder, you can use the camera’s W.B. button to change the white balance setting. The setting appears in the display panel next to the W.B. mark.

**Note:**

You cannot change settings as described above when in the Full Auto camera mode. To change the camera mode, see “Making camera mode settings” on page 2-28.

For details on making white balance adjustments, see “Adjusting the white balance setting” on page 2-16.

## Adjusting the exposure setting

When taking pictures with the viewfinder, you can use the camera's + or - button to change the exposure setting. The setting appears in the display panel next to the +/- mark.

### **Note:**

*You cannot change the settings described above when in the Full Auto camera mode. To change the camera mode, see "Making camera mode settings" on page 2-28.*

For details on making exposure adjustments, see "Making basic exposure adjustments" on page 2-18, and "Making advanced exposure adjustments" on page 2-19.

## Taking Pictures Using the LCD monitor

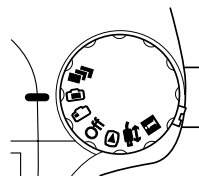

Using the LCD monitor allows you to verify the whole image before shooting and confirm the image right after shooting. When you want to take pictures using the panorama or digital zoom features, or when taking close-ups, use the LCD monitor.

### **Note:**

- You can turn on and off the indication from the LCD monitor by pressing the MENU button.
- You can also make audio recordings when taking pictures with the LCD monitor. See "Making Audio Recordings for Photos" on page 2-25.
- You can use basic playback function in the  dial position. See "Using the basic playback feature" on page 2-13.

Follow these steps to take pictures using the LCD monitor.

1. Turn the camera's dial switch to . You will see a live preview on the LCD monitor. Center your subject on the screen.

**Note:**

- ❑ *Hold the camera firmly with both hands and keep the posture for a while when you press the shutter button.*
  - ❑ *Make sure you are not blocking the lens with your finger, strap, clothing, or other object.*
2. If you are using the camera in bright sunlight, you can improve the clarity of your LCD monitor and save battery power by using your camera's skylight. Slide the backlight switch to the ☀ position. The backlight of the LCD monitor turns off and the skylight cover opens to let sunlight into the camera.

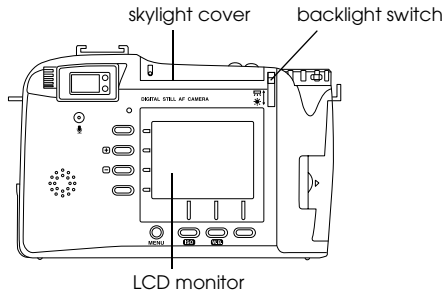

3. Hold the shutter button halfway down to lock the auto focus. A small green circle ● appears on the upper right corner of the monitor. If you wish, you can now move your subject off-center without altering the focus.

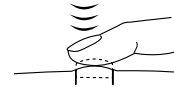

When you are in the Program and Manual camera modes, the shutter speed and aperture appear at the top of the LCD monitor.

4. Press the shutter button the rest of the way down to take the photo.





5. Hold the camera still until the status light above the LCD monitor comes back on or until the camera beeps. Then release the shutter button.



When you press the shutter button, the monitor freezes and displays the picture until the camera finishes processing it. You can delete the image while it is being displayed on the monitor by pressing **Delete**. After the status and shooting lights turn green, you can take another photo and display or manage your photos. See Chapter 3, “Viewing and Managing Your Photos,” on page 3-1.

### ***Using the basic playback feature***

When you are taking photos with the LCD monitor, you can easily use the basic playback feature to play back photos you have already taken. In the Full Auto or Program camera mode, press  on the LCD monitor. In the Manual camera mode, press **Menu Change** and then  on the LCD monitor.

When you play back photos, you can enlarge, erase, view multiple photos, and play back audio recordings. See the following sections:

To enlarge photos, see “Magnifying photos” on page 3-2.

To erase photos, see “Erasing photos” on page 3-5.

To view either four or nine photos at a time, see “Displaying multiple photos” on page 3-1.

To play back audio recordings, see “Playback with the built-in speaker” on page 2-27.

### ***Using the digital zoom feature***

There are two ways to enlarge images, using the optical (×3) and digital (×2) zoom features. When you use both at the same time, you can enlarge images as much as six times.

Your PhotoPC 850Z’s digital zoom feature allows you to double the size of your images. Follow the steps below.

1. Turn the camera’s dial switch to .
2. Press the button at the bottom left of the LCD monitor until a yellow frame appears around the previewed image and **DIGITAL ZOOM** appears briefly in the center of the monitor.

If you want to use the digital zoom feature and continuous shooting features together, turn the dial switch to .

3. Frame your subject in the LCD monitor and press the shutter button.

### ***Using the macro setting to take close-ups***



For best results when taking pictures of objects 20 to 50 centimeters away from the camera, use the macro feature. Follow the steps below.

1. Turn the camera's dial switch to
2. Press the button at the bottom left of the LCD monitor until a green frame appears around the previewed image and MACRO appears briefly in the center of the monitor.

If you want to use the continuous shooting and macro features together, turn the dial switch to

3. Frame your subject in the LCD monitor and press the shutter button.

### ***Taking panoramas***



You can take panoramas using the LCD monitor. Follow the steps below.

1. Turn the camera's dial switch to
2. Press the button at the bottom left of the LCD monitor until a black frame appears above and below the previewed image, and PANORAMA appears briefly in the center of the monitor.

If you want to use the continuous shooting feature while taking panoramas, turn the dial switch to

3. Frame your subject in the LCD monitor and press the shutter button.

#### ***Note:***

- ❑ *You cannot select Standard image quality when taking panoramas. For an explanation of image quality settings, see "Adjusting the image quality" on page 2-7.*
- ❑ *With the PhotoPC 850Z, the file size of a panorama photo is half the file size of any other photo of the same image quality.*

---

## ***Making Settings in the LCD Monitor Dial Position***

This section covers the various settings you can make when using your camera in the LCD monitor dial position. The settings range from basic to advanced, and the availability of these settings change according to the current camera mode setting. To change the camera mode setting, see “Making camera mode settings” on page 2-28.

### ***Making predefined exposure settings***

The PhotoPC 850Z has four predefined exposure settings that are accessible when in the Program camera mode.

#### ***When to use a predefined exposure setting***

##### **Normal**

For taking basic photographs. Uses the following settings:

- Auto exposure
- Divided brightness metering system

##### **Sports**

For photographing quickly moving subjects. Uses the following settings:

- High shutter speed
- Automatic sensitivity
- Divided brightness metering system

##### **Portrait**

For photographing portraits. Uses the following settings:

- Aperture fixed at f2.0 (WIDE) or f2.8 (TELE)
- Spot metering system

##### **Landscape**

For photographing landscapes or scenery. Uses the following settings:

- Aperture priority
- Divided brightness metering system

### ***How to change the predefined exposure setting***

1. Make sure Program camera mode is selected. (See “Making camera mode settings” on page 2-28.)
2. Then turn the camera’s dial switch to .
3. Press Program to select Normal, Sports, Portrait, or Landscape.

### ***Adjusting the white balance setting***

The PhotoPC 850Z has three white balance settings that are accessible when in the Program or Manual camera mode.

### ***When to adjust the white balance***

Your camera’s white balance default setting is AUTO, which means white balance is adjusted for your photos automatically. At certain times you may want to adjust the white balance setting so that the colors in your images appear more like those seen by the eye.

When taking pictures at dusk, for example, set white balance to FIX to increase reddish color tones in your images. When taking pictures under white light, however, keep white balance set to AUTO to avoid a green tone in your images. Use CUSTOM to make user settings. See “Making user settings for white balance” on page 2-33.

### ***How to adjust the white balance***

Follow the steps to adjust the white balance.

1. Make sure you are using the Program or Manual camera mode. (See “Making camera mode settings” on page 2-28.)
2. Turn the camera’s dial switch to .
3. In the Program camera mode, press the W.B. button to select AUTO, FIX or CUSTOM.



In the Manual camera mode, press Menu Change. Press the W.B. button to select AUTO, FIX or CUSTOM, and then press BACK to save your setting.

**Note:**

- ❑ You can see the value for the white balance setting on the display panel.
- ❑ You can also make white balance settings when taking pictures with the viewfinder by pressing the W.B. button.
- ❑ You can make a custom white balance setting. See “Making user settings for white balance” on page 2-33.

**Adjusting the sensitivity setting**

Your PhotoPC 850Z has the following sensitivity settings:

-  Standard sensitivity, equivalent to ISO 100
-  High sensitivity, equivalent to ISO 200
-  Super high sensitivity, equivalent to ISO 400

**When to adjust the sensitivity**

Set the sensitivity to high or super high when taking photos:

- ❑ Of fast moving subjects (useful for in-door sports)
- ❑ Of distance subjects with a flash
- ❑ In the dark without a flash (useful when flash photography is prohibited)

EPSON recommends setting sensitivity to standard  at all other times, as image quality is lower when you use higher sensitivity settings.

**How to adjust the sensitivity**

Follow the steps below to change the sensitivity.

1. Make sure you are using the Program or Manual camera mode. (See “Making camera mode settings” on page 2-28.)
2. Turn the camera’s dial switch to .
3. In the Program camera mode, press the ISO button to select standard, high, or super high sensitivity.

In the Manual camera mode, press Menu Change. Press the ISO button to select standard, high, or super high sensitivity, and then press BACK to save your setting.

**Note:**

- ❑ You can see the value for the sensitivity setting on the display panel.
- ❑ You can also make the sensitivity setting when taking pictures with viewfinder by pressing the ISO button.

## **Making basic exposure adjustments**



Exposure refers to the amount of light the camera captures when a photo is taken.

The camera's default exposure setting is AUTO, meaning the exposure is adjusted automatically. However, you can manually adjust the exposure to change the darkness or brightness of your photos for certain conditions.

### **When to adjust the exposure**

Increase the exposure setting when:

- ❑ You want to make your photos lighter.

- ❑ The photo you have taken is too dark, and you want to increase the brightness.
- ❑ You are taking pictures of a white object which may tend to look grayish in the photos.
- ❑ You are taking pictures of an object with a bright background, such as a chair in front of a sunlit window.
- ❑ You are taking photos at the beach or in the snow on sunny days, or taking photos of an object with a white background.

Reduce the exposure setting when:

- ❑ You want to make your photos darker.
- ❑ The photo you have taken is too bright, and you want to increase the darkness.
- ❑ You are taking pictures of a black object which may tend to look grayish in the photos.
- ❑ You are taking pictures of an object with a black background.

## How to adjust the exposure

Follow the steps below to change the exposure setting.

1. Make sure you are using the Program or Manual camera mode. (See “Making camera mode settings” on page 2-28.)
2. Turn the camera’s dial switch to .
3. In the Program camera mode, press the + button to raise the exposure value or the - button to lower the exposure value. You can make nine different settings in increments of 0.5 from -2.0 to 2.0 EV.

When you select Auto Exposure, Shutter Priority, or Aperture Priority in the Manual camera mode, you can adjust the exposure. Press the + button to raise the exposure value or the - button to lower it. You can make 21 different settings in increments of 0.2 from -2.0 to 2.0 EV.

### Note:

- ❑ You can see the value for the exposure setting on the display panel.
- ❑ You can set the exposure settings when taking pictures with the viewfinder and you set Program or Manual camera mode in Setup position. Use the + button to go up the value or - button to go down the value of the exposure.

- ❑ *Photographic experience and knowledge is necessary to correctly adjust exposure. Be sure to make proper exposure settings when taking important photos.*
- ❑ *When shooting under poor photographic conditions, EPSON recommends taking several photos of the same object using different exposures.*

## Making advanced exposure adjustments

When you use the Manual camera mode, you can set the correct exposure manually by changing the shutter speed and the aperture. Select any exposure mode among Auto Exposure, Shutter Priority, Aperture Priority, and Manual Exposure. Although these exposure modes are similar to the predefined program modes available in the Program camera mode, you can make advanced exposure adjustment manually.

### Note:

*Photographic experience and knowledge is necessary to adjust the shutter speed and the aperture correctly. Be sure to make appropriate settings when taking important photos.*

You can set shutter speeds from 4 to 1/800 seconds. You can set an aperture to f2 (not available for Tele), f2.8, f4, f5.6, f8, or f11.

## **Auto Exposure**

Auto Exposure is an easy-to-use feature to adjust the shutter speed and the aperture automatically for the correct exposure. Select the auto exposure as follows.

1. Make sure you are using the Manual camera mode. (See “Making camera mode settings” on page 2-28.)
2. Turn the camera’s dial switch to .
3. Press the button at the top left of the LCD monitor to select Auto Exposure.

### **Note:**

*You can adjust the exposure finely with the + or - button.*

## **Shutter Priority**

Shutter priority allows you to select the shutter speed first, so that the camera automatically adjusts the aperture for the correct exposure. Select the shutter priority as follows.

1. Make sure you are using the Manual camera mode. (See “Making camera mode settings” on page 2-28.)
2. Turn the camera’s dial switch to .
3. Press the button at the top left of the LCD monitor to select Shutter Priority.
4. Press the ISO or W.B. button to select the shutter speed.

### **Note:**

*You can adjust the exposure finely with the + or - button.*



## Aperture Priority

Aperture priority allows you to select the aperture first, so that the camera automatically adjusts the shutter speed for the correct exposure. Select the aperture priority as follows.

1. Make sure you are using the Manual camera mode. (See “Making camera mode settings” on page 2-28.)
2. Turn the camera’s dial switch to .
3. Press the button at the top left of the LCD monitor to select Aperture Priority.
4. Press the ISO or W.B. button to select the aperture.

### **Note:**

*You can adjust the exposure finely with the + or - button.*

## Manual Exposure

Manual Exposure allows you to adjust the shutter speed and the aperture manually to set your desired exposure. Select the manual exposure as follows.

1. Make sure you are using the Manual camera mode. (See “Making camera mode settings” on page 2-28.)

2. Turn the camera’s dial switch to .
3. Press the button at the top left of the LCD monitor to select Manual Exposure.
4. Press the ISO or W.B. button to select the aperture and press the + or - button to select the shutter speed.

## Making manual focus settings



When in the Manual camera mode, you can make focus settings manually. Follow these steps.

1. Make sure you are using the Manual camera mode. (See “Making camera mode settings” on page 2-28.)
2. Turn the camera’s dial switch to .

If you want to make focus settings manually when using the macro feature or taking panoramas, press the button at the bottom left of the LCD monitor until MACRO or PANORAMA appears in the center of the screen.

3. Press Menu Change.

4. Press the + or - button to select a manual focus setting.

When using the normal or panorama frame or digital zoom feature, you can select AF for auto focus,  (when the subject is about 0.8 meters away),  (when the subject is about 2.5 meters away), or  (when the subject is more than three meters away).

When using the macro feature, you can make settings from MACRO1 (when the subject is about 0.2 meters away), MACRO2 (when the subject is about 0.5 meters away), or AF for auto focus. The smaller the value, the closer the focus becomes.

## Changing the metering system

Your camera is set to the divided brightness metering system by default. When in the Manual camera mode, you can change freely between the divided brightness and spot metering systems.

### Note:

*When taking photos with the Portrait exposure setting, the camera automatically uses the spot metering system. To select the Portrait exposure setting, see “Making predefined exposure settings” on page 2-15.*

## When to change the metering system

Use the spot metering system for most photographic situations.

Use the divided brightness metering system when:

- Taking pictures of objects that have a bright background, such as a chair in front of a sun-lit window
- There is a clear contrast in shading between the upper and lower part of the frame

## How to change the metering system

Follow the steps below to change the metering system.

1. Make sure you are using the Manual camera mode. (See “Making camera mode settings” on page 2-28.)
2. Turn the camera’s dial switch to .
3. Press Menu Change. To change the metering system, press Metering.



When the divided brightness metering system is selected, a square icon with nine squares appears in the lower right corner of the screen.



When the spot metering system is selected, a square icon with a small circle appears in the lower right corner of the screen.

---

## Taking Multiple Exposures

To use the continuous shooting or time lapse shooting feature, turn the camera's dial switch to

### Using the continuous shooting feature

This shooting feature is useful when you want to break down a complex motion into a series of easy-to-see steps. It is also useful to take several pictures, then choose from those the ones you like best. When the image quality is set to Standard, you can take close to two photos per second, up to ten photos. When the image quality is set to Fine, you can take close to one photo per second, up to 10 photos. When you select Super Fine, you can take one photo per second, up to five or six photos.

#### Note:

- ❑ When using continuous shooting, you cannot use the flash or select the HyPict image quality setting.

- ❑ You cannot make an audio recording when using the continuous shooting feature.
- ❑ The settings you make in the dial position remain when you use the continuous shooting feature. Turn the dial switch to and make the appropriate settings.

Follow these steps to take pictures using the continuous shooting feature.

1. Turn the camera's dial switch to . A red frame appears around the previewed image, and CONTINUOUS appears on the LCD monitor.
2. You can adjust the image quality and use the self timer with the buttons on the top of the camera. The self timer creates a ten second delay between the time you press the shutter button and the moment the actual image is captured.

#### Note:



- ❑ When using continuous shooting, you cannot use the flash or select the HyPict image quality setting.
- ❑ If you need to make more settings, turn the camera's dial switch to . After you finish making settings, turn the dial switch back to and go to the next step.

3. Press the shutter button and hold it down to begin taking a series of photos.
4. Release the button to stop taking pictures.

### **Using the time lapse feature**

This feature allows your camera to automatically take pictures at a preset time interval. Use this feature creatively to capture scenes that change over time, such as sunsets, plant life, or a busy street corner. You can set the time interval from ten seconds to 24 hours.

#### **Note:**

- ❑ *When using the audio recording or the HyPict image quality, the shortest time interval available is 20 seconds instead of ten.*
  - ❑ *The settings you make in the  dial position remain when you use the continuous shooting feature. Turn the dial switch to  and make the appropriate settings.*
1. Turn the camera's dial switch to . A red frame appears around the previewed image and CONTINUOUS appears at the top of the LCD monitor.
  2. Press Mode Change and INTERVAL appears on the LCD monitor.

3. The hours, minutes, and seconds appear in the center of the screen with seconds highlighted. Press the + and - buttons to change the value of the highlighted time unit. To highlight a different time unit, press the ISO and W.B. buttons.

You can choose an interval of 24 hours by pressing Max Interval at the top left of the LCD monitor.

You can choose the shortest available interval, ten or 20 seconds, by pressing Min Interval.

4. Once you have set the desired time, begin taking photos by pressing the shutter button.

#### **Note:**

- ❑ *The camera may automatically turn off after you take the first picture; it automatically turns back on to take pictures at the set time.*
  - ❑ *When using the self timer feature, the camera takes a photo ten seconds after you press the shutter button, then continues taking photos at the set time lapse interval.*
5. To stop taking photos, turn the camera's dial switch to Off.

---

## Making Audio Recordings for Photos

Your PhotoPC 850Z has a built-in microphone for recording messages to attach to your photos. You can make three, five or ten second audio recordings just after shooting photos with the LCD monitor. You can also make recordings for previously taken photos.

### **Note:**

- ❑ *To play back audio recordings with your camera, see “Playback with the built-in speaker” on page 2-27*
- ❑ *You can also play back audio recordings with the EPSON Photo!3 software. See the EPSON Photo!3 User’s Guide for instructions.*
- ❑ *To erase audio recordings, see “Erasing audio recordings” on page 3-8.*

## Right after taking photos

To make audio recordings just after taking photographs, you need to first make a few settings. Follow these steps.

### **Note:**

- ❑ *You cannot make audio recordings when taking photos with the viewfinder.*
  - ❑ *When using the quick or continuous shooting feature or when the HyPict image quality setting is selected, you cannot make audio recordings right after taking photos. You can make audio recordings after taking photos. See “For existing photos” on page 2-26.*
1. Turn the camera’s dial switch to **1**.
  2. Press the ISO button. REC appears on the bottom of the LCD monitor, and the current audio recording setting appears below REC.
  3. Press the W.B. button to choose a different audio recording setting. You can choose between three, five or ten second recordings.

### **Note:**

*If you do not want to make audio recordings after taking pictures, choose OFF.*

4. To make recordings when taking pictures with the LCD monitor, turn the dial switch to .

**Note:**

- ❑ *To make recordings when using the continuous shooting or time lapse feature, turn the dial switch to . See “Using the continuous shooting feature” on page 2-23, or “Using the time lapse feature” on page 2-24.*
  - ❑ *You cannot make recordings when taking pictures using the viewfinder.*
5. Frame your subject in the LCD monitor and press the shutter button.
  6. The captured image appears on the screen momentarily, then the camera begins the audio recording. A countdown of the recording time appears on the screen. You can record a message until the time runs out by speaking into the built-in microphone on the back of the camera.

### **For existing photos**

To make recordings for previously taken photos, follow these steps.

1. Turn the dial switch to .

2. Display the photo for which you want to make an audio recording.
3. Press Menu Change. Then press Sound.
4. You can make three, five, or ten second recordings. Press the button next to the desired time.

If there is already a message for the current photo, a confirmation message appears. To erase the old recording and make a new one, press Yes. Press NO to cancel recording.

When the image is locked, the message appears. Press RELEAse to unlock the image before recording. Press BACK to cancel the operation. After you unlock the image, press Yes to start recording or NO to cancel recording.

5. A countdown of the recording time appears on the screen. You can record a message until the time runs out by speaking into the built-in microphone on the back of the camera.

## Playback with the built-in speaker

You can play back the messages recorded for photos with the built-in speaker. Follow these steps.

1. Turn the dial switch to **⏮**.
2. Press the + or - button to select any photo to play back the recorded message.
3. Press Menu Change.
4. Press Sound.
5. Press the W.B. button. The camera plays back the sound.

### **Note:**

- ❑ *To stop during playback, press the W.B. button again.*
- ❑ *You can adjust the speaker volume. See “Adjusting the speaker volume” on page 2-31.*

---

## Making Additional Settings

When the camera’s dial is in the **1** position, you can change certain camera settings, including the internal clock, the camera mode, the beep, the LCD monitor’s brightness level, speaker volume, and the automatic shut-off time. You can also set the display language.

### Setting the time and date

1. Turn the dial switch to **1**.
2. The date (month, day, and year) and the time (hour and minute) appear on the upper left of the LCD monitor. Press the button next to the date and time.
3. To adjust the value of the highlighted item, use the + and - buttons. To change which item is highlighted, use ISO and W.B. buttons.
4. After setting the correct time and date, save the settings by pressing SET.

**Note:**

- You will have to reset the time if the camera is unplugged and the batteries are removed for more than 30 minutes.
- You can also set the time and date with your computer. See the EPSON Photo!3 User's Guide for details.

## **Making camera mode settings**

The PhotoPC 850Z has three camera modes to fit your photographic needs. Each mode gives you a different amount of control over the camera settings, whether taking photos with the viewfinder or LCD monitor. Read this section to choose the appropriate mode, and to change the mode if necessary.

### **Choosing a camera mode**

#### **Full Auto camera mode**

Allows you to take basic photos without having to make complex settings. Available settings include:

- Flash, including auto, forced, red-eye reduction, and off
- Self timer
- Image quality

- Optional zoom
- Digital zoom (when using the LCD monitor)
- Macro, Panorama or Normal frame (when using the LCD monitor)
- Quick playpack of photos and messages (when using the LCD monitor)

#### **Program camera mode**

For users who want a moderate amount of control over the camera's functions. Available settings include:

- All settings available in Full Auto camera mode
- Slow sync flash
- Sensitivity
- Predefined exposure (when using the LCD monitor)
- Fine exposure adjustment (0.5 EV increments)
- Basic or custom white balance



### Manual camera mode

For experienced users who want complete control over the camera's wide array of settings and features. Available settings include:

- ❑ All settings available in Full Auto camera mode
- ❑ Slow sync flash
- ❑ Sensitivity
- ❑ Fine exposure adjustment (0.2 EV increments)
- ❑ Manual exposure adjustment using the auto exposure, shutter priority, aperture priority, or manual exposure feature (when using the LCD monitor)
- ❑ Manual focus features (when using the LCD monitor)
- ❑ Spot and divided brightness metering systems (when using the LCD monitor)
- ❑ Basic or custom white balance

### Changing the camera mode

To change the camera mode setting, follow these steps.

1. Turn the camera's dial switch to **1**. The current camera mode setting appears on the LCD monitor next to the + button.
2. Press the + button to select the camera mode.

### Quick shooting feature

After taking a picture, the PhotoPC 850Z takes a few seconds to process and save the image in the installed memory card. During this time you cannot take a photo, which means that you need to wait a few seconds before taking a second photo. The quick shooting feature allows you to take up to ten pictures without a delay by temporarily saving all the images in the camera, and then later saving them to the memory card.

#### **Note:**

*When using the Super Fine image setting, you can only take up to five or six photos without a delay.*

To turn on the quick shooting feature, follow these steps.

1. Turn the camera's dial switch to **1**. Normal Shot appears next to the - button on the LCD monitor.
2. Press the - button to turn on the quick shooting function: Normal Shot changes to Quick Shot. When you take pictures, the image quality mark on the display panel flashes, indicating that the quick shooting function is on.

**Note:**

- ❑ *When the image quality is set to HyPict, the quick shooting function is disabled.*
- ❑ *The flash does not work when using the quick shooting feature.*
- ❑ *You cannot make audio recordings when using the quick shooting feature.*
- ❑ *When battery power is low or CompactFlash Card memory does not have enough free space, you cannot use the quick shooting feature.*
- ❑ *When using the quick shooting feature, bracketed numbers on the display panel indicate the number of the pictures saved temporarily in the camera.*

## **Setting the automatic shut-off feature**

When using this feature, your camera saves battery power by automatically turning off when idle for a designated period of time. You can have the camera turn off after ten seconds, 30 seconds, one minute, three minutes, or five minutes. This feature is only effective when using batteries to power the camera.

**Note:**

*When the camera is connected to a computer with a serial cable, the power automatically turns off when the camera is idle for one minute.*

## **Changing the setting**

To change this feature's setting, follow these steps.

1. Turn the camera's dial switch to **1**.
2. Press the ISO button. The current setting appears on the top left of the LCD monitor.
3. To change the Power Save setting, press Power Save next to the current setting. You can select 10 sec, 30 sec, 1 min, 3 min, or 5 min.
4. Press BACK to return to the previous screen.

### ***Turning the camera back on***

When the dial switch is set to an orange icon, you can turn the camera back on by pressing the shutter button, or turning the dial switch off, then on again.

When the dial switch is set to **1** or **2**, you can turn the camera back on by pressing any button on the back of the camera, or by turning the dial switch off, then on again.

### ***Setting the LCD monitor's brightness***

Follow the steps below to change the LCD monitor's brightness level.

1. Turn the dial switch to **1**.
2. Press the ISO button.
3. Press the + or - button to increase or decrease the brightness level.

### ***Adjusting the speaker volume***

You can adjust the volume of the built-in speaker. Follow these steps.

1. Turn the dial switch to **1**.
2. Press the ISO button.
3. Press Volume to adjust the speaker volume: Volume Hi or Low appears on the monitor.
4. Press BACK to return to the previous screen.

### ***Setting the beep***

You can have the camera beep whenever you press any of its buttons, only when you use the shutter button, or never. Follow these steps to change the beep setting.

1. Turn the dial switch to **1**.
2. Press the ISO button. Then press the ISO button to select Always, Shutter, or Never.
3. Press BACK to return to the previous screen.

## Selecting slow synchro timing

You can select flash timing for slow synchro. The leading synchro is a normal setting that is suitable for most cases. The trailing synchro is a special setting that is effective in expressing motion. Follow the steps below to select the slow synchro timing.

1. Turn the camera's dial switch to **1**.
2. Press Shot SETUP.
3. Press Synchro Flash to select Leading or Trailing.
4. Press BACK to return to the previous screen.

### Note:

- ❑ You cannot select the slow synchro timing when the Full Auto camera mode is selected.
- ❑ To use the selected timing, select slow synchro for the flash. See "Setting the flash" on page 2-9.

## Selecting the internal or external flash

The PhotoPC 850Z has a convenient built-in flash. It satisfies ordinary flash needs. If you need more light, you can attach an external flash, which is available as a camera accessory sold separately, to the PhotoPC 850Z.

Slide the mounting foot of the flash into the hot-shoe attachment on the top of the PhotoPC 850Z and secure the lock mechanism. For details about the flash, see its user's guide.



### Warning:

Be sure to turn off the camera and flash before connecting them.

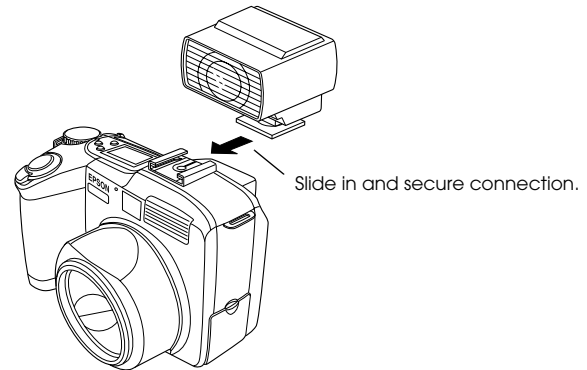

Follow the steps below to select the internal or external flash.

1. Turn the camera's dial switch to **1**.
2. Press Shot SETUP.

3. Press the + button to select INT for the built-in flash or EXT for the external flash.
4. Press BACK to return to the previous screen.

**Note:**

- ❑ *The external flash can work in all camera modes. EPSON recommends you use the Manual camera mode to use the external flash.*
- ❑ *When you use the external flash, the internal flash setting is disabled and the  button does not work.*

### Changing the color/monochrome setting

You can take both color and monochrome photos with the PhotoPC 850Z. To select color or monochrome, follow these steps.

**Note:**

*The file size of photos is the same for color and monochrome.*

1. Turn the dial switch to **1**.
2. Press Shot SETUP to change the setting screen.
3. Press the button at the bottom left to select Color or B/W on the monitor.
4. Press BACK to return to the previous screen.

### Making user settings for white balance

Following the steps below to create your own white balance setting.

**Note:**

*The custom white balance setting does not change when the camera is turned off.*

1. Turn the camera's dial switch to **1**.
2. Press Shot SETUP.
3. Press the W.B. button. A message appears asking you if you want to save the new settings. Press Yes to continue making settings.
4. Place a white sheet in front of the camera lens so that it is previewed on the whole LCD monitor.

You can also use a colored sheet. For example, to create a sepia hue, use a blue sheet. To create a blue hue, use a yellow sheet. Experiment with other colors for different effects.

**Note:**

*To cancel the white balance setting, press BACK.*

5. Press the shutter button to make the new setting.

To use your custom white balance setting, see “Adjusting the white balance setting” on page 2-16.

### **Selecting the signal system and language**



Depending on the country of purchase, you need to choose the NTSC or PAL signal system to meet your local television broadcasting standards. You can also choose English, Japanese, French, German, Italian, Portuguese, Spanish or Chinese as the language used to display camera information on the LCD monitor. To select the signal system and language, follow the steps below.

1. Turn the camera’s dial switch to **1**.
2. Press the W.B. button.
3. Press the ISO, W.B., +, and - buttons to highlight your language.
4. Press Signal system to select NTSC or PAL .
5. Press SET to save your settings.

### **Selecting a folder in the CompactFlash Card**

If there is more than one folder in your CompactFlash Card, you can use your camera to change the folder your camera accesses. To change the folder, follow these steps.

1. Turn the camera’s dial switch to **1**.
2. Press Memory SETUP. The name of the folder being currently accessed appears on the left side of the LCD monitor, in the middle.
3. Press the + or - button to change the folder.

---

### **Viewing the Color Guide**

The *Color Guide*, included in your Color Guide CD-ROM, contains ideas for taking pictures with your digital camera and working with your digital images, and provides useful information on color imaging.

You need one of the following browsers, or an equivalent, to view the *Color Guide*.

- Netscape Navigator 4.0 or later
- Microsoft Internet Explorer 4.0 or later

If a browser is not installed in your computer, you need to obtain one and install it, or you can install the browser that comes with your Color Guide CD-ROM. For further details, double-click the Readme.txt (for Windows) or Read Me First icon (for Macintosh), and follow the instructions.

To view the Color Guide, insert the Color Guide CD-ROM and double-click your computer's CD-ROM drive icon, then double-click color.htm (for Windows) or Color Guide (for Macintosh).





# Viewing and Managing Your Photos

---

This chapter explains how to view photos on your camera's LCD monitor, your computer monitor, or a television set. It also includes explanations on how to lock and erase photos, and how to turn the photo information display on or off with the controls on your camera.

This chapter covers the following topics.

- Displaying photos on your camera
- Erasing photos
- Preventing photos from being erased
- Viewing photo information
- Viewing photos on your computer, television, or projector

---

## Viewing Photos with the LCD Monitor

When your camera's dial switch is in the  position, you can use the camera's LCD monitor to view your photos in a variety of ways. You can also view detailed information about each photo.

### **Note:**

*Only EPSON Photo File Format images can be enlarged, have audio recordings attached, or display photo information.*

## Displaying multiple photos

The PhotoPC 850Z's monitor can display one, four or nine photos at a time. To change the number of photos displayed, follow these steps.

1. Turn the camera's dial switch to . A photo appears on the LCD monitor.

**Note:**

*The message No Images appears when there are no photos saved in the camera's memory card.*

2. To display four images at a time, press the ISO button once. Small "thumbnail" images of the last four photos you took appear on the screen, with the currently selected image framed in white.

Press the ISO button again to change the screen. Small "thumbnail" images of the last nine photos you took appear, with the currently selected image framed in white.

3. Press the + or - button to move the white frame forward or back through the images. Hold the button down to move through the images quickly.

When the frame reaches the first or last photo of the current group, the previous or next group of images is displayed.

4. To display one photo, press the ISO button.

## **Magnifying photos**

You can view a magnified version of any image saved in your camera with the camera's LCD monitor. The image is magnified by four and is divided into nine parts.

1. Turn the camera's dial switch to .
2. To magnify the currently displayed photo, press enlargement.
3. A magnified view of the photo appears, and an icon in the top right corner of the screen indicates the portion of the image currently being displayed. Scroll the screen up and down with the + and - buttons, or right and left with the W.B. and ISO buttons.

**Note:**

*When magnifying a panorama picture, the image is divided into three parts, and you can only scroll left and right.*

4. To exit the magnification screen, press BACK.

## Viewing a slide show of your photos

The slide show feature automatically plays back photos on your camera's LCD monitor. Your PhotoPC 850Z's slide show includes navigation features and gives you full control of the photos in your slide show. To use the slide show, follow these steps.

### Note:

To adjust the monitor brightness, see "Setting the LCD monitor's brightness" on page 2-31.

1. Turn the camera's dial switch to **Ⓛ**.
2. Press Menu Change, and then press SLIDE SHOW.
3. Press Sound Play to turn on or off playpack of the recorded messages.
4. Press the + button to select the slide show speed. You can have the photos change automatically every three, five, or ten seconds, or you can choose to change the photos manually.

You can change photos by pressing the + or - button during the manual slide show. Press the + button for the next photo or the - button for the previous photo.

5. Press Start to begin the slide show.

To pause the slide show, press Pause. When paused, you can use Restart to restart the slide show, the ISO button for the previous photo, Exclude to exclude the photo from the slide show, or Quit to stop the slide show halfway.

To stop the slide show halfway, press Quit at the bottom left of the LCD monitor.

## Excluding or adding photos

All photos saved in the memory card in your camera are automatically included in the slide show. To exclude any of the photos from the slide show, or to add any excluded photos to the slide show, follow these steps.

1. Turn the camera's dial switch to **Ⓛ**.
2. Press Menu Change, and then press SLIDE SHOW.
3. Press the - button.

To make choosing photos easier, you can display either four or nine photos at a time by pressing the ISO button once or twice. A white frame appears around the selected photo.

**Note:**

*A number appears in each photo that is currently included in the slide show.*

4. To exclude a photo from the slide show, press the + or - button to move the white frame until it is around the photo, and then press Exclude. To exclude all the photos, press Exclude All.

To include a photo from the slide show, press the + or - button to move the white frame until it is around the photo, and then press Select. To include all the photos, press Exclude All two times. Numbers appear in the upper left corner of each photo, indicating that they are all included in the slide show.

5. When you are finished making changes, press BACK, and then follow steps 3 and 5 in "Viewing a slide show of your photos" on page 3-3.

**Rotating photos**

You can display photos in the slide show rotated 90 degrees to the right or left. To rotate a photo, follow these steps.

1. Turn the camera's dial switch to .
2. Press Menu Change, and then press SLIDE SHOW.
3. Press the - button. Then, if necessary, press the + or - button to display the photo you want to rotate.
4. To rotate the photo 90 degrees in either direction, press Rotate once or twice.

To rotate more photos, repeat steps 3 and 4.

5. When you are finished making changes, press BACK, and then follow steps 3 and 5 in "Viewing a slide show of your photos" on page 3-3.

## Viewing photo information

You can view the following information about the currently displayed photo on the LCD monitor.

Image Number:	Folder name and image number in the memory card. (e) indicates the photo is based on the Design rule for camera file system.
Date:	Month/day/year and time
Shutter Speed:	4 to 1/800
Aperture:	f2 to f11
Exposure adjustment:	+2.0 to -2.0
Flash:	Indicates the flash setting used when the photo was taken.
White Balance:	Auto, fixed, or custom
Others:	Icons that indicate the sensitivity and metering system settings. Icon that indicates the macro or panorama feature used. D-ZOOM that indicates the digital zoom (no icons)

To display this photo information, follow these steps.

1. Turn the camera's dial switch to .
2. Press Menu Change, and then press the W.B. button.
3. To exit the photo information screen, press BACK.

---

## Managing Photos with the LCD Monitor

### Erasing photos

You can erase one photo, several photos, or all the photos at a time when using the LCD monitor.

### Erasing individual photos

To erase photos saved in your memory card one at a time, follow the steps below.

1. Turn the dial switch to .
2. Press the + or - button to display the photo you want to erase.

To make choosing photos easier, you can display either four or nine photos at a time by pressing the ISO button once or twice. A white frame appears around the selected photo.

3. Press Delete to erase the photo.
4. A confirmation message appears. Press Yes to erase the photo. Press No to cancel.

### ***Erasing all the photos***

To erase the photos from the memory card in your camera all at once, follow these steps.

1. Turn the camera's dial switch to .
2. Press the W.B. button . Then press Select All to select all the photos in the memory card.
3. Press ISO button to erase all the photos.
4. A confirmation message appears. Press Yes to erase all the photos. Press No to cancel.

### ***Note:***

*If any photos are locked, a message appears asking if you want to erase the locked photos. Press No to erase only the unlocked photos. Press Yes to erase all photos, including those that are locked. To lock or unlock photos, see "Locking and unlocking photos" on page 3-7.*

### ***Erasing selected photos***

To erase selected photos from the memory card in your camera, follow these steps.

1. Turn the dial switch to .

To make choosing photos easier, display either four or nine photos at a time by pressing the ISO button once or twice. A white frame appears around the selected photo.

2. Press the W.B. button. Then press the + or - button to move the white frame until it is around a photo you want to erase.
3. To select that photo, press Select. A red frame appears around the selected photo.
4. To select more photos, repeat steps 2 and 3.

5. After you have selected all the photos you want to erase, press the ISO button to erase them.
6. A confirmation message appears. Press Yes to erase the selected photos. Press No to cancel.

**Note:**

*If any photos are locked, a message appears asking if you want to erase the locked photos. Press No to erase only the unlocked photos. Press Yes to erase all photos, including those that are locked. To lock or unlock photos, see “Locking and unlocking photos” on this page.*

### **Locking and unlocking photos**

Use the lock feature to protect your photos from being accidentally erased.

#### **Locking and unlocking all the photos**

To lock or unlock all the photos in the camera’s memory card at once, follow these steps.

1. Turn the dial switch to .
2. Press the W.B. button.

3. If Select appears in the lower left corner of the screen, there are some unlocked photos. Press Select All to select all the photos. All photos are framed in red.

If Release appears in the lower left corner of the screen, all the photos are already selected.

4. Press the W.B. button.
5. To lock the photos, press Lock.  
To unlock the photos, press Release.
6. Press BACK to return to the previous screen.

#### **Locking and unlocking selected photos**

To lock or unlock selected photos from the memory card in your camera, follow these steps.

1. Turn the camera’s dial switch to .  
  
To make choosing photos easier, display either four or nine photos at a time by pressing the ISO button once or twice. A white frame appears around the selected photo.
2. Press the W.B. button. Press the + or - button to move the white frame until it is around a photo you want to lock.

3. To select that photo, press **Select**. A red frame appears around the photo.
4. To select more photos, repeat steps 2 and 3.
5. Press **W.B.** button.
6. To lock the selected photos, press **Lock** .  
  
To unlock the selected photos, press **Release**.
7. Press **BACK** to return to the previous screens.

### ***Erasing audio recordings***

To erase audio recordings from the memory card in your camera, follow these steps.

**Note:**

*To make audio recordings, see “Making Audio Recordings for Photos” on page 2-25.*

1. Turn the dial switch to **Ⓜ**.
2. Use the **+** or **-** button to select a photo whose attached audio recording you want to erase. (A microphone icon appears in the images with attached recordings.)
3. Press **Menu Change**.

4. Press **Sound**.
5. To erase the selected photo’s audio recording, press the **ISO** button.

If the selected photo is locked, a message appears telling you the image is also locked. To unlock the photo, press **Release**.

6. A message appears asking you to confirm whether you want to erase the audio recording. Press **Yes** to erase the recording, or **No** to cancel.
7. Press **BACK** twice to exit the screens.



---



## Using Your Computer

You can use your PhotoPC 850Z to transfer pictures saved in memory card to your computer. This allows you to view your photos on your computer monitor and use them in your letters, presentations, or just about anything you create on your computer. You can also manage the pictures in the camera's memory card from your computer.

To use your camera with your computer, first install EPSON Photo!3, then connect the camera to the computer. See the *EPSON Photo!3 User's Guide* for details. It contains the following information.

- ❑ Installing EPSON Photo!3 and EPSON Photo File Uploader3
- ❑ Connecting the PhotoPC 850Z to your computer
- ❑ Transferring pictures to your computer
- ❑ Erasing pictures from the camera's memory card
- ❑ Using pictures in your documents
- ❑ Uploading image files to the camera's memory card
- ❑ Uploading programs to the camera

### Note:

- ❑ When the camera is connected to your computer with a cable, it turns off automatically after one minute of inactivity. It comes back on when you turn off the camera and reset its dial switch to .
- ❑ The camera's dial switch must be set to  after connecting to your computer and before you start EPSON Photo!3. The LCD monitor displays a photo, then turns off automatically to save battery power.

---

## Viewing Pictures on a Television

You can display the images and play back audio recordings in the camera's memory card on a regular television simply by using the AV cable that came with your PhotoPC 850Z.

### Note:

Television telecasting specifications are different depending on the country. Select NTSC or PAL to meet the video signal specifications in your country. See "Selecting the signal system and language" on page 2-34.

The following procedure is one example of connecting the PhotoPC 850Z to your television.

1. Make sure the camera and television are turned off.
2. Open the connector cover on the side of the camera.

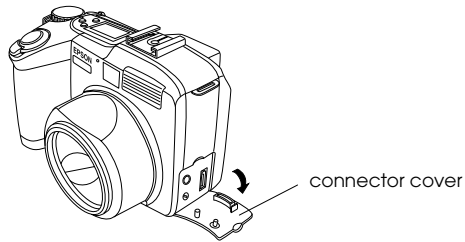

3. Connect the AV cable to the AV OUT port on the camera as shown below.

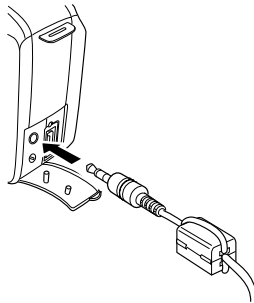

4. Connect the other end of the AV cable to the audio and video input ports on the television.

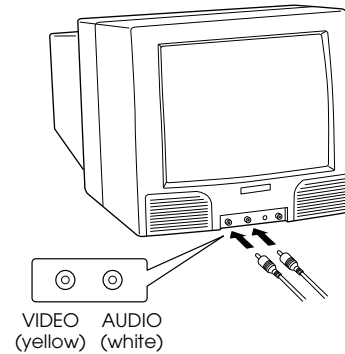

5. Turn on the television and switch it to video mode.
6. Turn the camera's dial switch to .

The last picture you took appears on the television screen and the LCD monitor turns off automatically.

---

## ***Viewing Pictures with an EPSON Projector***

You can display the images in your camera on an EPSON Projector by using the video cable that came with your PhotoPC 850Z.

See your EPSON Projector documentation for more details.



# Using Direct Print to Print Photos

---

There are two ways to print the photos you take with your PhotoPC 850Z.

- ❑ You can transfer the images to your computer and print them from application software. For instructions on transferring images, see the *EPSON Photo!3 User's Guide*.
- ❑ You can connect the PhotoPC 850Z directly to your printer to print the images, using the Direct Print program installed in your camera. This chapter describes how, and includes information on the following topics.

Direct Print's features and requirements

Printing your images

LCD monitor and display panel messages

Printed image dimensions

---

## Features

Direct Print includes the following features.

- ❑ Color, monochrome, blue, and sepia printing
- ❑ Print all, Print, Album, Sticker, and Index (contact sheet) printing formats
- ❑ Fast, Fine, and Normal printing modes

---

## Requirements

You need the following items to use the Direct Print program.

Digital camera: EPSON PhotoPC 850Z

Printer: Using the Direct Print Program  
Ver. 3.0:

EPSON STYLUS PHOTO  
EPSON STYLUS PHOTO EX  
EPSON STYLUS PHOTO 700  
EPSON STYLUS PHOTO 750  
EPSON STYLUS PHOTO 1200  
EPSON STYLUS COLOR 740

Interface cable: Macintosh serial cable  
(comes with your camera)

Paper: Special papers distributed by EPSON  
(See the following list.)

Photo Quality Ink Jet Paper (A3)	S041068
	S041045
Photo Quality Ink Jet Paper (A4)	S041061
	S041026
Photo Quality Ink Jet Card (A6)	S041054
Photo Quality Ink Jet Paper (Letter)	S041029
	S041062
Photo Paper (A3)	S041142
Photo Paper (A4)	S041140
Photo Paper (4 × 6)	S041134
Photo Paper (Letter)	S041141
High Quality Glossy Film (A4)	S041071
Photo Quality Glossy Film (A6)	S041107
Photo Quality Glossy Film (Letter)	S041072
Photo Stickers (A6)	S041144
Photo Stickers 4 (A6)	S041176

### Note:

- ❑ *The availability of special media varies by country.*
- ❑ *Ink jet printers are particularly sensitive to the condition of your paper. Keep unused paper in its original packaging and store it in a cool, dark place.*
- ❑ *Using the optional AC adapter (B867\*\*1) with your camera is recommended. This avoids interrupted printing caused by low battery power.*

---

## Connecting your camera to the printer

Follow these steps to connect your camera to a printer.

1. Make sure both the camera and the printer are turned off.
2. Connect one end of the Macintosh serial cable to the serial connector on the back of the printer.

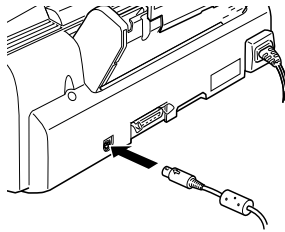

3. Open the connector cover on the side of the camera.

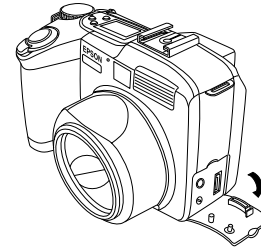

4. Plug the connector cable into the camera's interface port.

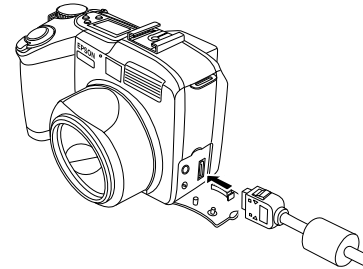

### **Caution:**

*Be sure to position the cable correctly before pushing it into the connector. Otherwise, the cable's pins may be damaged.*

---

## ***Installing the Direct Print Program***

Your PhotoPC 850Z comes with Direct Print Ver. 3.0 installed. If you uninstalled the program and want to use it again, you can reinstall the program from the included CD-ROM.

You can install Direct Print in your camera from your computer using EPSON Program Uploader. This utility is installed in your computer automatically when you install the EPSON Photo!3. To install these programs, see the *EPSON Photo!3/File Uploader3 User's Guide*.

You can also install the Direct Print program using a memory card. For instructions on using these cards, see "Copying or deleting programs using a memory card" on page 6-3.

You can delete the Direct Print program from your camera using the Program Uploader Utility. See the *EPSON Photo!3/File Uploader3 User's Guide* for instructions. You can also use your PhotoPC 850Z to delete the program from a memory card. See "Copying or deleting programs using a memory card" on page 6-3.

---

## ***Printing Your Images***

The Direct Print program controls all the print settings between your camera and the connected printer. After accessing Direct Print, use it to select a format before printing your images.

### ***Accessing the Direct Print program***

1. Connect your camera and printer. (See "Connecting your camera to the printer" on page 4-3.)
2. Make sure the printer is off, then turn your camera's dial switch to .
3. Press DirectPrint. The Direct Print program's top menu appears on the monitor.

To decide a print format, see the next section.



## Choosing a print format

The Direct Print program features five different formats. This section shows each format and includes nine charts with each format's available settings. Before printing, choose a format from the following diagrams.

### ❑ Print All / Print format

The Print All format prints all the photos in the memory card. The Print format prints individual photos. You can print one to four images on a sheet of paper depending on the paper size. You can also print several copies of individual images.

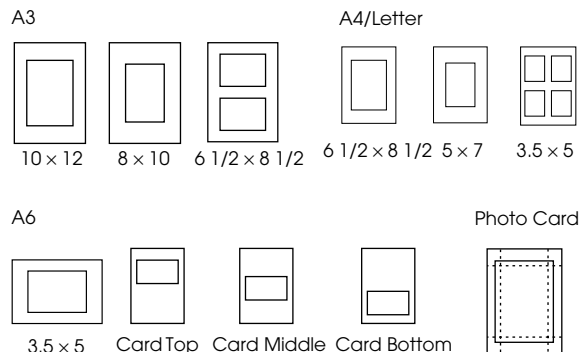

Item	Choices
Paper Size	A3, A4, Letter, A6, PhotoCard
Layout	10 × 12, 8 × 10, 6.5 × 8.5, 5 × 7, 3.5 × 5, PhotoCard, Card Top, Card Middle, Card Bottom,
Information	On or Off (Date and Time)
Filter	None, Monochrome, Sepia, Blue
Paper Type	Glossy Paper, Glossy Film, Inkjet Paper
Print Mode	Fine, Fast, Normal

❑ Index format

Prints small “thumbnail” images of all the photos in your camera on A4, Letter, or A6 size contact sheets.

Item	Choices
Paper Size	A4, A6, Letter
Layout	Index
Information	On or Off (A6 size: The number of the photo A4 / Letter size: The number of the photo, date)
Filter	None
Paper Type	Glossy Paper, Glossy Film, Inkjet Paper
Print Mode	Fine, Fast, Normal

A4/Letter

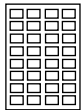

A6



❑ Album format

Prints up to three images on A4 or Letter size paper. Photos are placed on the left. When the photos are rotated, two images are printed on a sheet.

Item	Choices
Paper Size	A4, Letter
Layout	Album
Information	On or Off (The number of the photo, date, time, shutter speed, aperture, audio recordings, ruled line)
Filter	None, Monochrome, Sepia, Blue
Paper Type	Glossy Paper, Glossy Film, Inkjet Paper
Print Mode	Fine, Fast, Normal

A4/Letter

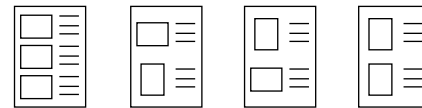

## ❑ Sticker format

Prints onto EPSON Photo Stickers. You can print 16 small copies (for Photo Stickers) or four small copies (for Photo Sticker 4) of the selected image onto each Photo Sticker sheet.

Item	Choices
Paper Size	Sticker 16, Stickers 4
Layout	Sticker 16 1 photo × 16, 2 photos × 8, 4 photos × 4  Stickers 4 1 photo × 4, 2 photos × 2
Filter	None
Paper Type	Glossy Film
Print Mode	Fine, Normal

Sticker 16



Stickers 4



## Printing procedures

### Making settings

Before printing, you need to make the print format, paper size, layout, photo information, and filter settings. Follow these steps to make each setting.

1. Access the Direct Print program as described in “Accessing the Direct Print program” on page 4-4.
2. Press the button next to the format you want to use.
3. To select a paper size, press Paper Size.
4. To select a layout, press Layout.
5. Press Information to change the information setting. To print photo information under the photo, select On.
6. Press Filter to select the filter.

Keep the camera on and go to the next section to select a photo to print.

**Note:**

- ❑ *The available settings and the information contents vary depending on the print mode you have selected. See the previous section for more information on each mode.*
- ❑ *When you select Photo Card as the paper size, you cannot display photo information.*

### **Selecting the photo**

Follow these steps to select the photo you want to print.

1. Press Photo Selection. Thumbnail images of the first nine photos in the memory card appear.

When using the Print All or Index format, all photos in the memory card are already selected. Skip to step 4.

When using the Print, Album, or Sticker format, the currently selected image is framed in white.

2. Press the ISO or W.B. button to frame the image you want to print.

3. Press the + button to print one copy of the framed image. A check mark appears on the image you select. Press the + or - button to change the number of copies. If you change the number to 0, the check mark disappears.

To rotate the photo 90 degrees in either direction, press Rotation once or twice. An icon appears on the image, indicating the orientation of the photo when printing.

**Note:**

- ❑ *You can print up to 99 copies when using the Print All or Print format. You can only print one copy when using the other formats.*
- ❑ *Depending on the format, you may not be able to rotate the photo.*

4. Press BACK. A confirmation message appears. To continue, press Done.

To change the settings, press Cancel and go back to step 1.

To reset the settings, press Reset and go back to step 2.

## Printing the photos

1. To start printing, press the W.B. button. The current print settings appear on the screen.

**Note:**

*To change the print settings, press the ISO button, and then make other settings.*

2. Press the + button to select the paper type. The available paper type and print mode vary depending on the selected print format.
3. To change the print quality setting, press Print Mode. You can choose Normal, Fine, or Fast.

**Note:**

*For information on paper types and print modes, see your printer's documentation, and the instructions that came with your media.*

4. To adjust the position of the paper, press Adjust. You can adjust the position left, right, up, or down a total of 10 mm, in increments of 0.2 mm. When you finish adjusting the position, press BACK.
5. Turn on the printer and load the size and type of media you selected. For loading instructions, see your printer's documentation, and the instructions that came with your media.

6. Press the W.B. button to print. The camera starts sending image data to the printer.

While the camera sends data and prints, the LCD monitor goes blank, star icons move across the display panel on the top of the camera, and the shooting light blinks green.

**Note:**

*To cancel printing, hold down the camera's MENU button. A message stating printing is cancelled appears on the LCD monitor for five seconds. The printer stops printing and ejects the media.*

7. When you finish printing, press BACK to exit the Direct Print program. Then turn the camera's dial switch to Off and turn off the printer.

---

## LCD Monitor and Display Panel Messages

When printing with the Direct Print program, a variety of status messages may appear on the camera's LCD monitor or the printer's display panel. For detailed explanations of these messages, see the following tables.

### LCD monitor messages

Message	Explanation
No Photos in Memory.	This message appears when there are no photos in memory. Press OK to return to the previous screen.
Please Select at least one photo to print.	There are no photos selected. Press OK to return to the previous screen and select a photo.
Unsupported printer model. Please connect supported model.	<p>The camera is not connected to an appropriate printer. Connect the camera to a printer described on page 4-2, then press any button to make print settings. (To cancel printing, hold down the MENU button.</p> <p>You selected Paper Size that your printer does not support. Select an appropriate paper size. (For information on available paper sizes, refer to your printer's documentation.)</p>

Connection or printer error.	Printing was interrupted because of a printer error. Clear the error, then start printing again from the beginning. (For information on clearing printer errors, see your printer's documentation.)
OK to erase printing settings?	You are about to erase the current print settings. To erase the settings, press Yes.
Batteries are low. Use AC adapter.	Battery power is almost out. Connect the camera to the AC adapter.
Error. Settings reset to default.	An error occurred while the Direct Print program was working. The settings you have made returned to their default values. To go back to the main menu, press OK.
Insert a Memory Card in the camera.	There is no memory card in the camera. Insert a memory card. For instructions, see "Installing and removing a CompactFlash Card" on page 1-10.
Printing canceled.	You held down the MENU button while printing. The printer stops printing and ejects the paper. This message disappears after three seconds.
Printing canceled. Reset printer and camera.	An error occurred. The printer stops printing and ejects the paper. This message disappears after three seconds.

## Display panel messages

Message	Explanation
E51: Another interface is active	The printer is receiving a print job through another interface. When the print job ends, the printer begins printing from the Direct Print program automatically.
E55: No ink	Printing stopped because the printer ran out of ink. Replace ink cartridges as needed and start printing again from the beginning. (For information on replacing ink cartridges, see your printer's documentation.)
E56: No paper or paper jam	Load paper into the printer, then press the printer's  load/eject button to begin printing. (Or hold down the camera's MENU button to cancel printing.) Printing stopped because paper is jammed in the printer. To remove the paper from the printer, see your printer's documentation.

## Printed Image Dimensions

### Print All /Print format

Layout setting	Paper Size setting	Image Dimensions
10 × 12	A3	339 × 254 mm
8 × 10	A3	271 × 203 mm
6.5 × 8.5	A3 / A4 / Letter	220 × 165 mm
5 × 7	A4 / Letter	180 × 136 mm
3.5 × 5	A4 / Letter / A6	128 × 89 mm
Photo card	Photo Card	158 × 106 mm
Card	A6	89 × 67 mm

4

### Index format

A4/Letter: 36 × 27 mm

A6: 23 × 17 mm

### Album format

A4/Letter: 109 × 81 mm

***Sticker format***

Sticker 16:                   27 × 20 mm

Stickers 4:                   56 × 42 mm



# Using Print Mark to Print Photos

---

Your PhotoPC 850Z comes with the Print Mark program that conforms to the new digital print standard, Digital Print Order Format. The program makes the DPOF file and saves it in the memory card installed in your camera. You can print photos in the memory card easily with the DPOF file.

The DPOF file allows you to select photos to print, specify the number of copies, and print the index of photos. Because you can save these print directions in advance, you can easily print photos with printers that are compatible with the DPOF standard and EPSON IP-100. In some countries, you will find photo shops that can deal with this standard. You do not need to give them troublesome print directions. Just pass your memory card to them. They simply set the card to the DPOF-compatible printer.

This chapter explains how to use Print Mark, and includes information on the following topics.

Print Mark's features

Making the DPOF file

Confirming and changing the DPOF file

Deleting the DPOF file

LCD monitor messages

---

## Features

You use Print Mark on your PhotoPC 850Z and save a Digital Print Order Format file in the memory card installed in your camera. The file includes the following print directions:

- Select photos to print
- Specify number of prints
- Print an index of photos

**Note:**

- ❑ *The Print Mark program shows indications in English on the LCD monitor regardless of your language selection.*
- ❑ *The Print Mark program can handle up to 1,000 photos in the memory card. If the card has more photos, it cannot access the photos exceeding the limit.*

---

## **Installing the Print Mark Program**

Your PhotoPC 850Z comes with Print Mark Ver. 2.0 installed. If you uninstall the program and want to use it again, you can reinstall the program from the included CD-ROM.

You can install Print Mark in your camera from your computer using EPSON Program Uploader. This utility is installed in your computer automatically when you install EPSON Photo!3. To install these programs, see the EPSON Photo!3/File Uploader3 User's Guide.

You can also install the Print Mark program using a memory card. For instructions on using these cards, see "Copying or deleting programs using a memory card" on page 6-3.

You can delete the Print Mark program from your camera using the Program Uploader Utility. See the EPSON Photo!3/File Uploader3 User's Guide for instructions. You can also use your PhotoPC 850Z to delete the program from a memory card. See "Copying or deleting programs using a memory card" on page 6-3.

---

## **Making the DPOF File**

The Print Mark program allows you to make a Digital Print Order Format file and save it in the memory card installed in your camera. You can select a Standard or Index layout to print photos. When you select the Standard layout, you can add an index print.

**Note:**

*You can make and save only one DPOF file in the memory card of your camera. The new one replaces the old one.*

## **Printing photos in a standard layout**

You can print photos in a standard (one per sheet) layout. You can also print an index together with standard layout prints. Follow these steps to make a new DPOF file.

1. Turn your camera's dial switch to .
2. Press PrintMark. The Print Mark program's main menu appears on the LCD monitor.

3. Press New settings.

**Note:**

*If a previous DPOF file exists, a message appears to confirm if you want to delete it. Press Done to continue or Cancel.*

4. Press the + button to select a one-per-sheet layout.
5. Press Select Image, and then the saved photos appear on the LCD monitor.
6. Press the ISO or W.B. button to select a photo. A white frame moves to indicate your selection. The number at the bottom of the LCD monitor is a frame number.

**Note:**

- ❑ *The Print Mark program can handle up to 1,000 photos. Even if the memory card has more photos, the program cannot access the photos exceeding the limit.*

- ❑ *You can enlarge the preview of the selected photo by pressing the enlargement icon button at the top left of the LCD monitor. Press BACK to return to the normal selection screen.*
7. Press the + or - button to specify the number of copies of the selected photo to print. You can specify up to 99 copies. When you specify values other than 00, the selection mark appears on the selected photo. The value 00 implies no selection.
  8. Repeat steps 6 and 7 to select other photos and specify the number of copies.
  9. Press BACK. The message appears to confirm how many frames are selected.
  10. Press Done to confirm your settings. If you change your mind, press BACK to return to the photo selection screen. To quit making a new DPOF file, press Cancel.
  11. If you need an index, press Add Index. Proceed to the next step. If you do not need an index, skip to step 15.

- Press the + button to select None, Selected, or All.

Button	Result
None	No index sheet is printed.
Selected	The index sheets of the selected photos are printed.
All	The index sheets of all photos in the memory card are printed regardless of your selection.

- When you select Selected or All, press the ISO or W.B. button to select the number of index copies. You can specify up to 99 copies of the index.
- Press BACK to return to the previous screen.
- Press SAVE to show the confirmation screen.
- Press the W.B. button to save your settings; the screen changes to the main menu of the Print Mark program.

If you want to change the current settings, press BACK to return to the previous screen. You can change the settings in the same way as you did with Add Index and Select Image.

- Press Exit to return to the program selection menu.

## Printing an index of photos

You can print photos in an index (several per sheet) layout. Follow these steps to make a new DPOF file.

- Turn your camera's dial switch to .
- Press PrintMark. The Print Mark program's main menu appears on the monitor.
- Press New settings.

### Note:

*If a previous DPOF file exists, a message appears to confirm if you want to delete it. Press Done to continue or Cancel to quit.*

- Press the - button to select a several-per-sheet layout.
- Press the + button to select All or Selected.

Button	Result
All	The index sheets of all photos in the memory card are printed. Skip to step 12.
Selected	The index sheets of the selected photos are printed. Proceed to the next step.

**Note:**

*The Print Mark program can handle up to 1,000 photos. Even if you select All, the program cannot access the photos exceeding the limit.*

6. Press **Select Image** to select photos to print as an index.
7. Press the **ISO** or **W.B.** button to select a photo. A white frame moves to indicate your selection. The number at the bottom in the LCD monitor shows a frame number.

**Note:**

❑ *The Print Mark program can handle up to 1,000 photos. Even if the memory card has more photos, the program cannot access the photos exceeding the limit.*

❑ *You can enlarge the preview of the selected photo by pressing the enlargement icon button at the top left of the LCD monitor. Press **BACK** to return to the normal selection screen.*

8. Press the **+** or **-** button to specify the number of copies to print the selected photo. You can specify up to 99 copies. When you specify values other than 00, the selection mark appears on the selected photo. The value 00 implies no selection.

9. Repeat the above steps 7 and 8 to select other photos and specify the number of copies.
10. Press **BACK**.
11. Press **Done** to confirm your settings. If you change your mind, press **BACK** to return to the photo selection screen. To quit making a new DPOF file, press **Cancel**.
12. Press the **ISO** or **W.B.** button to select the number of index sheet copies. You can specify up to 99 sheet copies of the index.
13. Press **Save** to show the confirmation screen.
14. Press the **W.B.** button to save your settings; the screen changes to the main menu of the Print Mark program.

If you want to change the current settings, press **BACK** to return to the previous screen. You can change the settings in the same way as you did with **Index print**, **Select Image**, and the **ISO** and **W.B.** buttons.

15. Press **Exit** to return to the program selection menu.

---

## Confirming and Changing the DPOF File

To confirm or change the current DPOF file you have made with the Print Mark program, follow the steps below.

1. Turn your camera's dial switch to .
2. Press PrintMark. The Print Mark program's main menu appears on the monitor.
3. Press the + button to show the confirmation screen. You can confirm the current settings on the LCD monitor.
4. Press the ISO or W.B. button.

Button	Result
ISO	You can change and save the settings in the same way as you make new settings.
W.B.	You can confirm the selected frames (or photos) and the number of copies on the LCD monitor. Press the ISO and W.B. buttons to select photos, so that you can see the number of copies of the selected photo to print.

### Note:

You can enlarge the preview of the selected photo by pressing the enlargement icon button at the top left of the LCD monitor. Press BACK to return to the normal selection screen.

5. Press BACK until you return to the main menu of the Print Mark program.
6. Press Exit to return to the program selection menu.

---

## Deleting the DPOF File

To delete your DPOF file, follow the steps below.

1. Turn your camera's dial switch to .
2. Press PrintMark. The Print Mark program's main menu appears on the monitor.
3. Press Delete. The message appears to confirm deletion.
4. Press Done to execute deletion. To return to the main menu, press Cancel.
5. To quit the Print Mark program, press Exit.

**Note:**

*Pressing New settings allows you to make a new DPOF file.*

---

## LCD Monitor Messages

When you use the Print Mark program, you may see error and status messages on the LCD monitor. For detailed explanations of these messages, see the following tables.

Message	Explanation
No photos in memory.	This message appears when there are no photos in the memory card. Press BACK to return to the program selection menu. Turn off the camera and insert a memory card that contains photos.
Error! Unable to access DPOF file.	This message appears when you remove the memory card while using the Print Mark program. Press BACK to return to the main menu. Turn off the camera and insert the memory card.  Note: Never remove the memory card during operation, otherwise you may not be able to use photos in the memory card.
No memory Card Inserted.	The memory card is not inserted in the camera. Insert the memory card and press BACK.

Message	Explanation
Batteries are low. Use AC adapter.	Battery power is almost out. Press BACK. Connect the AC adapter to the camera.  Note: When this message appears while making the DPOF file, you cannot save the new settings.
You can no longer select an image.	You have reached the maximum number of selectable photos to print. Press BACK. If you want to select other photos, cancel any other selections.
You lost last print settings. Are you sure?	The DPOF file already exists in the memory card. Press Cancel to cancel operation. Press Done to make a new DPOF file. Making a new file replaces the old one. The memory card can have only one DPOF file.
DPOF file made by other writer exists.	This message appears when the Print Mark program first tries to read an invalid DPOF file made by other cameras. Press Delete and new settings button to delete the invalid file and make a new file. Press BACK to cancel and make new settings.

Message	Explanation
Unable to save DPOF file. No memory space in card.	The memory card has no space to save a DPOF file. Press any button to cancel operation and return to the program selection menu. If you want to make a DPOF file, delete unnecessary photos and try again.



# Camera Options and Accessories

---

This chapter covers the variety of available options that expand the memory and flexibility of your PhotoPC 850Z.

The following topics are included in this chapter.

Using CompactFlash memory cards

Using the PCMCIA adapter

Using the AC adapter

Using the lens adapter

---

## Using Memory Cards

The PhotoPC 850Z comes with 4 MB of internal memory mainly for storing optional software programs, and an 8 MB CompactFlash Card to store photos.

**Note:**

*You need a memory card in your PhotoPC 850Z before you take pictures. It has been installed in the camera at shipment. To install a memory card, see "Installing and removing a CompactFlash Card" on page 1-10.*

The following table shows the storage capacity of a CompactFlash Card.

	Standard	Fine	Super Fine	HyPict
8 MB* CompactFlash Card	120	24	12	10

\* For information about the availability of CompactFlash Cards in your area, contact your EPSON dealer.

**Note:**

- ❑ *The number of photos you can save on a memory card may differ slightly from the chart above, depending on the complexity of each photo.*
- ❑ *If you attach an audio recording to a photo saved in your memory card, the number of photos you can save on that card may decrease.*

### **Installing a memory card into your computer**

You can install a memory card into a computer equipped with a Type II PCMCIA memory card slot. This allows you to copy photos directly from your memory card to your computer, and to copy programs to or erase programs from your camera using your memory card. Follow these steps.

1. If necessary, remove the memory card from the camera. See “Installing and removing a CompactFlash Card” on page 1-10.

2. Insert the memory card all the way into the optional adapter, as shown below.

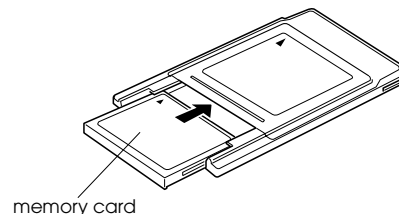

3. Insert the adapter into your computer's Type II PCMCIA slot.

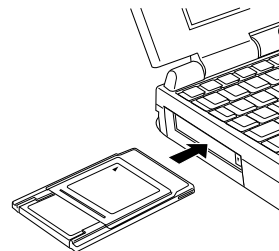

To copy photos from a memory card to your computer, see the next section.

To copy programs to or erase programs from your camera using your memory card, see “Copying or deleting programs using a memory card” on this page.

## Copying photos directly to a computer

To copy photos directly from your memory card to your computer, follow these steps.

### Note:

- ❑ *Macintosh users must enable the PC Exchange extension software to access files on memory cards. See your Macintosh documentation for more information.*
  - ❑ *You can also access the photos in your memory card with the included EPSON Photo!3 software. For instructions, see the EPSON Photo!3 User’s Guide.*
1. Install the memory card into your computer. See “Installing a memory card into your computer” on page 6-2.
  2. Find and double-click the DCIM folder in your computer. Then double-click the 100EPSON folder. Your image files appear.
  3. Double-click a file to view its thumbnail image.
  4. Copy photos to the desired folder in your computer.

### Note:

- ❑ *The PhotoPC 850Z saves files in the automatically generated 100EPSON folder.*
- ❑ *Photo images you have taken are named automatically when they are saved. For example, 91020001. The first digit, 9, is the last number of the year you took photo. The next digit, 1, is the month, January. (October, November, and December are represented by X, Y, and Z, respectively.) The next two digits, 02, represent the day. The last four digits, 0001, indicate the order the file was saved. Image files use the JPG extension, and audio recording files use the WAV extension.*

## Copying or deleting programs using a memory card

To copy programs to or erase programs from your camera using your memory card, follow these steps.

### Note:

- ❑ *You can also upload programs to your memory card from your computer using the EPSON Program Uploader utility. See EPSON Photo!3 User’s Guide.*
- ❑ *Macintosh users must enable the PC Exchange extension software to access files on memory cards. See your Macintosh documentation for more information.*

1. Install the memory card into your computer. See “Installing a memory card into your computer” on page 6-2.
2. Create a folder in the card and name it OP-PROG.
3. Copy the opld8501.prg file from the CD-ROM’s OP-PROG folder to the memory card’s OP-PROG folder.

**Note:**

*Be sure to copy the opld8501.prg file into the OP-PROG folder, even when you want to delete a program from your camera. Otherwise, you cannot delete or copy programs.*

4. Copy the program file you want to install in your camera to the memory card’s OP-PROG folder.

**Note:**

- ❑ *The Direct Print program file is opd8501.fnc located in the CD-ROM’s OP-PROG folder. The Print Mark program file is oppm8501.fnc located in the CD-ROM’s OP-PROG\PRTMARK folder.*
- ❑ *Do not turn the dial switch while copying programs; otherwise, programs cannot be copied correctly. The incorrect dial switch operation results in malfunction of the camera.*

5. Remove the memory card from the computer and insert it in the camera.
6. Turn the camera’s dial switch to **1**. Then press Memory SETUP.
7. Press EXT SOFT.
8. To copy a program to the memory card, press the + button.

To delete a program from the camera, press the - button.

9. To choose the program you want to add or delete, press the + or - button, and then press Add or Delete.
10. A confirmation message appears. Press Yes to add or delete the program, or press No to cancel.

### **Formatting memory cards**

The included CompactFlash Card is already formatted when you buy it. You need to format a memory card only if you want to erase all the data on the card, or if a message on the LCD monitor instructs you to do so.

To format memory cards, follow these steps.



**Caution:**

*When you format a memory card, all the data on the card is lost, including any locked images.*

1. Make sure the memory card is installed in the camera. See “Installing and removing a CompactFlash Card” on page 1-10.
2. Turn the camera’s dial switch to **1**. Then press Memory SETUP.
3. Press MEMORY CARD FORMAT to format the memory card.

**Note:**

*If no memory card is installed in the camera, you cannot select MEMORY CARD FORMAT.*

4. A confirmation screen appears on the screen. Press YES to format the card. Press NO to cancel.

**Note:**

*If any photos in the memory card are locked, a message appears telling you that the photos will be erased if you reformat the card. Press YES to format the card. Press NO to cancel.*

---

## Using the AC Adapter

The AC adapter (B867\*\*1) allows you to connect your PhotoPC 850Z to a standard electrical outlet. This is especially useful when you are previewing pictures, transferring pictures, operating the camera from your computer or using Direct Print and Print Mark programs. The adapter powers the camera, but does not charge the batteries. In some locations the AC adapter comes with a separate AC power cable.

**Note:**

- ❑ *The asterisks are substitutes for the respective digits of the product number, which varies by country.*
- ❑ *Also read the AC adapter’s documentation before using this product.*



**Warning:**

- ❑ *Use only the AC adapter designed for the PhotoPC 850Z. Using any other adapter could cause fire, electrical shock, or injury.*
- ❑ *Do not use the AC power cable and the adapter for any purpose other than powering your PhotoPC 850Z.*
- ❑ *If the AC plug does not fit your outlet, have a proper outlet installed by a qualified electrician.*

- ❑ *To avoid radiation danger, do not expose or remove the ferrite core.*
- ❑ *To prevent fire or electric shock, do not cover the camera with a blanket.*

To avoid losing any images or settings, make sure the camera is finished processing and is turned off before you connect or disconnect the AC adapter. Then follow these steps.

1. If your AC adapter has a separate AC power cable, push the cable connector firmly into the AC inlet.

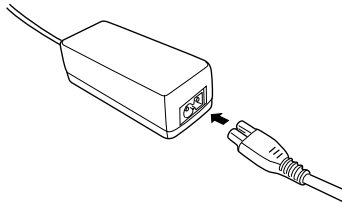

2. Open the connector cover on the side of the camera.

3. Plug the adapter cable into the DC port on the camera.

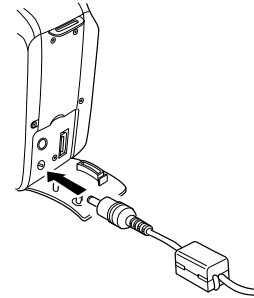

4. Plug the AC adapter into an electrical outlet.



**Caution:**

- ❑ *Place the camera and the AC adapter near an electrical outlet where the plug can be easily unplugged.*

**Note for French-speaking users:**

*Placez l'appareil photographique et ses options près d'une prise de courant où la prise peut être débranchée facilement.*

- ❑ *Avoid electrical outlets controlled by wall switches or automatic timers. Also, avoid outlets on the same circuit as large motors or other appliances that can cause fluctuations in line voltage.*

---

## Using the Lens Adapter

The lens adapter allows you to mount an accessory lens on the camera's lens. You can mount an accessory lens of 49 mm diameters sold separately.

Screw the lens adapter onto the camera's lens, and then screw an accessory lens on it.

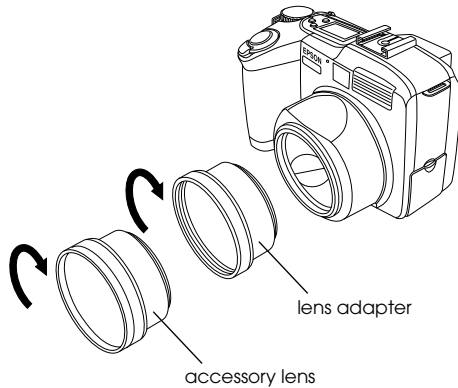

### **Note:**

- ❑ *When you use an accessory lens, use the LCD monitor to take photos.*
- ❑ *Do not attach an accessory lens directly to the camera.*





---

# Maintenance and Troubleshooting

Your PhotoPC 850Z is easy to take care of, and any problems you may have can be solved quickly and easily.

See the following sections for guidance on handling, cleaning, and storing the camera. For solutions to common camera problems, see the section beginning on page 7-3.

Handling, cleaning and storing the camera

Cleaning the battery charger

Solutions for camera and image problems

---

## Maintenance

Your PhotoPC 850Z requires only basic care. Before you do any maintenance procedures on the camera, be sure to read “Safety Instructions” on page 3. Then follow these guidelines.

### Handling the camera

- ❑ To avoid damaging the optics of the camera, do not expose the lens to direct sunlight for extended periods of time.
- ❑ Avoid sudden temperature changes, which can cause moisture to form on the camera and options. Keep the camera and options in a case or bag if you need to move them from a cold environment to a warm one. Allow time for the camera and options to adjust to temperature changes before using them.

## ***Cleaning the camera***

- ❑ Use a clean, dry cloth to keep the camera free of dust.
- ❑ Do not use harsh or abrasive cleaners.
- ❑ To clean the lens, make sure the camera is off, then blow off any loose dust or dirt. Next breathe on the lens and wipe off all moisture with a soft, lint-free cloth or lens cleaning tissue.
- ❑ If necessary, clean the battery contacts with a dry cloth.

## ***Storing the camera***

If you will not use the camera for a long period of time, remove the batteries and store them at a low temperature in a dry location and store the camera in its case. This prevents camera damage from battery leaks or corrosion.

Do not store the camera in the following locations.

- ❑ Where it will be exposed to direct sunlight; for example, on a car dashboard
- ❑ Near sources of bright light or high humidity
- ❑ Near sources of heat or in a closed car
- ❑ In areas of excessive dirt or dust
- ❑ Where it will be exposed to strong vibrations or magnetic fields

## ***Cleaning the battery charger***

- ❑ Disconnect the battery charger from the power outlet before cleaning.
- ❑ Do not use liquid, aerosol, harsh or abrasive cleaners.
- ❑ Wipe off dust with a clean, dry cloth.
- ❑ Keep the charger terminals clean by wiping them with a dry cloth.

---

## **Problems and Solutions**

Check this list of problems and possible solutions before calling your dealer for help.

### **Camera problems**

#### **The camera has no power.**

The camera may have turned off automatically. To turn the power back on, turn the camera off and back on again. Alternatively, you can turn the camera back on by pressing the shutter button, or pressing a button on the back of the camera, depending on your camera's dial switch position. See "Turning the camera back on" on page 2-31 for more details.

Make sure the batteries are installed correctly. See "Installing the batteries" on page 1-6. Also, make sure you are using appropriate batteries and that they are charged. See "Replacing the batteries" on page 1-8 and replace the batteries if necessary.

The batteries included with the camera need to be charged before use. See "Charging the batteries" on page 1-5 to charge the batteries.

If you are using the AC adapter, make sure it is plugged into a working outlet.

#### **You cannot see clearly through the viewfinder.**

Adjust the diopter by turning the correction dial next to the viewfinder. The dial switch must be at , otherwise you cannot adjust the diopter.

#### **The camera doesn't take a picture after you press the shutter button.**

The flash may be recharging. Wait until the shooting light beside the viewfinder turns green, and try again.

Make sure the memory card is installed correctly. To install a memory card, see "Installing and removing a CompactFlash Card" on page 1-10.

The camera's memory may be full. Check the picture counter on the display panel. If it reads 0, your camera's memory is full. Erase some pictures using the LCD monitor, or transfer the pictures to your computer and then erase them.

**Note:**

To erase pictures with the LCD monitor, see “Erasing photos” on page 3-5. To transfer pictures to your computer before erasing them, see the *EPSON Photo!3 User’s Guide*.





The camera may be connected to your computer. When it is connected, you cannot use any of the buttons on the camera itself. See the *EPSON Photo!3 User’s Guide* for instructions on taking pictures from your computer.

**The camera takes too long to take a picture.**

You may be pressing the shutter button all the way down at once. This forces the camera to focus, make exposure adjustments, and capture the image all at once. You can have the camera perform these operations separately to make the process more efficient. First, hold the shutter button halfway down to lock the auto focus, then press the shutter button the rest of the way down to take the photo. For more information, see “Taking Pictures Using the Viewfinder” on page 2-5, or “Taking Pictures Using the LCD monitor” on page 2-11.



If you want to take pictures quickly in succession, use the quick shooting feature. This will reduce the amount of time that the camera normally takes to process each picture. See “Quick shooting feature” on page 2-29.

**The flash does not work.**

Make sure the flash is set to , ,  or . See “Setting the flash” on page 2-9 for more information on setting the flash.

Make sure the batteries are installed correctly. See “Installing the batteries” on page 1-6. Also, make sure you are using appropriate batteries and that they are charged. See “Replacing the batteries” on page 1-8 and “Charging the batteries” on page 1-5.

When you use the continuous shooting feature, the flash is disabled.

**Nothing appears on the LCD monitor when the camera’s dial switch is set to ,  or .**

Make sure the batteries are installed correctly. See “Installing the batteries” on page 1-6. Also, make sure you are using appropriate batteries and that they are charged. See “Replacing the batteries” on page 1-8 and “Charging the batteries” on page 1-5.

The camera may be turned off automatically. To turn the power back on, turn the camera off and back on again. Alternatively, you can turn the camera back on by pressing the shutter button, or pressing a button on the back of the camera, depending on your camera's dial switch position. See "Turning the camera back on" on page 2-31 for more details.

The LCD monitor turns off automatically when you use EPSON Photo!3.

**The image on the LCD monitor is too dark, or is not visible at all.**

Adjust the brightness of the LCD monitor if necessary, following the instructions in "Setting the LCD monitor's brightness" on page 2-31.

Make sure the dial switch is set to ,  or .

The LCD monitor turns off automatically when you use EPSON Photo!3.

Make sure the skylight cover is not opened. Set the backlight switch to .

**You cannot take certain kinds of pictures or make the settings you want when using the LCD monitor.**

Some of the camera's settings and features cannot be used at the same time. For example, you cannot use the quick shooting feature and set the image quality to HyPict at the same time. For instructions on making camera settings, see Chapter 2, "Taking Pictures."

To adjust the white balance, exposure, and sensitivity settings, you must first select the Program or Manual camera mode. See "Making camera mode settings" on page 2-28.

**Nothing appears on the TV monitor when the camera is connected to your television.**

Make sure the AV cable is connected correctly, "Viewing Pictures on a Television" on page 3-9.

Make sure the camera's dial switch is set to .

Make sure the television is switched to the video mode.

Make sure the batteries are installed correctly. See “Installing the batteries” on page 1-6. Also, make sure you are using appropriate batteries and that they are sufficiently charged. See “Replacing the batteries” on page 1-8 and “Charging the batteries” on page 1-5.

Your camera may not be compatible with local television broadcasting standards. Select the NTSC or PAL signal system to meet the television broadcasting standards in your country. See “Selecting the signal system and language” on page 2-34.

**Note:**

*Also, see your television documentation for possible solutions.*

**You cannot take a picture with the camera when a memory card is installed.**

Check your camera’s LCD monitor for messages. If you get a message indicating that you need to format or eject the card. To format the memory card, see “Formatting memory cards” on page 6-4. To remove the card, see “Installing and removing a CompactFlash Card” on page 1-10.

Your card’s memory may be full. Check the picture counter on the display panel. If it reads 0, the memory is full. In this case, change to another card, erase some pictures using the LCD monitor, or transfer the pictures to your computer and then erase them.

**Note:**

*To erase pictures with the LCD monitor, see “Erasing photos” on page 3-5. To transfer pictures to your computer before erasing them, see the EPSON Photo!3 User’s Guide.*

**Even after you take a picture, the number on the display panel stays the same.**

This number shows how many more pictures you can take. The number may not change, depending on the image quality or complexity of the photos you take.

**You cannot copy software to or delete it from the memory card.**

Make sure the memory card is installed correctly. See “Installing and removing a CompactFlash Card” on page 1-10, and reinstall the memory card if necessary.

Make sure the memory card contains the folder and files necessary to copy or delete the program. See “Copying or deleting programs using a memory card” on page 6-3.

## **Picture problems**

If you are not satisfied with the pictures you get from your PhotoPC 850Z, you may need to adjust some of the camera’s settings, or you may need to brush up on your photography techniques. Read the suggestions listed below and give them a try.

### **Your pictures images on the screen and printed out are differ from the image displayed on the LCD monitor.**

The PhotoPC 850Z captures images in 24-bit color (16 million colors). Your pictures will not display maximum image quality if your monitor or your computer’s video controller does not support this color depth. You may need to upgrade your system to achieve the best possible image quality.

If the image on the LCD monitor and screen are different, check the gamma correction and color correction settings. Try a different combination of these settings.

If your pictures look better on the screen than when you print them out, you may need to upgrade your printer. EPSON color ink jet printers provide excellent image quality.

### **Your picture is blurry or out of focus.**

Make sure your subject is within the camera’s range. When sensitivity is set to Standard, make sure you are at least 50 centimeters away from the subject to take a picture without the flash. When you use the built-in flash, make sure of the effective flash range from 80 to 370 centimeters for wide-angle shot and from 80 to 260 centimeters for telephoto shot. When using the macro feature, you can take pictures within 20 to 50 centimeters of the subject with or without the flash.





Make sure the subject is not moving.

Be careful to hold the camera steady while the image is being captured.

Make sure your flash is not set to .

Make sure to center your subject. When you take photos using the viewfinder, center your subject in the cross-hairs.

### **Your picture is too dark (underexposed).**

You may need to use the flash. Set the flash to , ,  or , following the instructions in “Setting the flash” on page 2-9.

When you use the built-in flash, make sure of the effective flash range from 80 to 370 centimeters for wide-angle shot and from 80 to 260 centimeters for telephoto shot. When sensitivity is set to Standard and you are using the macro feature, stay 20 to 50 centimeters away from the subject.



If you need more light, attach a high capacity flash, which is sold separately as a camera accessory, to your PhotoPC 850Z. See “Selecting the internal or external flash” on page 2-32. For instructions, see the documentation of the flash.

You can adjust the exposure to make your photos brighter. See “Making basic exposure adjustments” on page 2-18, or “Making advanced exposure adjustments” on page 2-19.

Use image-editing software to adjust the picture's brightness and contrast.

If you are using the macro feature to take close-up photos, be sure to provide adequate lighting for your subject, since the camera's aperture is automatically set to the smallest setting.

### **Your picture is too light (overexposed).**

If you are using the forced flash  setting, the flash may be too bright. Try setting the flash to the automatic  setting. See “Setting the flash” on page 2-9.

You can adjust the exposure manually to make your photos darker. For instructions, see “Making advanced exposure adjustments” on page 2-19.

When you use the flash and the macro function together, you may find your pictures come out too light, since the flash is close to the subject. In this case, try turning the flash off .

If you are facing a bright light source, you may need to take your picture from a different angle.

You can adjust the exposure to make your photos brighter. See “Making basic exposure adjustments” on page 2-18, or “Making advanced exposure adjustments” on page 2-19.



Use image-editing software to adjust the picture's brightness and contrast.

When you use the external flash, EPSON recommends using the Manual camera mode to get the correct exposure.

### **Part of your picture is missing.**

Make sure you are not blocking the lens with your finger, strap, clothing, or other object.

### **A horizontal or vertical red line appears on your picture.**

Red lines are caused by glare. Avoid photographing very shiny surfaces that reflect light into your lens.

### **The wrong date and/or time is displayed on your camera.**

If you remove the batteries from your camera for a certain time period, you will need to reset the clock. See "Setting the time and date" on page 2-27 to set the clock using the LCD monitor. You can also set the clock from your computer. For instructions, see the *EPSON Photo!3 User's Guide*.

### **The color in your picture does not look right.**

When you take pictures under certain artificial lighting conditions, the colors may be slightly distorted. You can use image-editing software to adjust color.

When you want to get more realistically colored images (for example, reddish images at dusk), set the white balance to FIX. For instructions, see "Adjusting the white balance setting" on page 2-16.

### **Your pictures do not look as good as they used to.**

Your camera's lens may be dirty or dusty. Try cleaning it following the instructions in "Cleaning the camera" on page 7-2.

### **The area captured in the photo is different from what you saw in the viewfinder.**

Take care to look straight through the viewfinder.

When taking photos using the macro feature, be sure to use the LCD monitor rather than the viewfinder to frame your subject.

Keep in mind that the area visible through the viewfinder is slightly smaller than the area captured in the actual photo.



## Specifications

---

---

### Camera

Model G770A

### Physical dimensions

Width	126 mm
Height	82 mm
Depth	72 mm
Weight	400 g (without batteries, strap and memory card)
Temperature	Operating: 5 to 35°C Non-operating: -20 to 60°C
Humidity (non-condensing)	Operating: 30% to 90% Non-operating: 10% to 90%

### Product type

Type	Digital still AF camera with LCD monitor
CCD	1/2 inch color area CCD (2.1 M pixels)
Zoom	Optical ×3 zoom Digital ×2 zoom
LCD monitor	2.0-inch TFT color LCD monitor with dual lighting system, electric backlight and skylight (110 K pixels)
Internal ROM	4 MB (program memory only)
Memory card	CompactFlash Card

## Recorded image

Data type      JPEG image following Exif Ver.2.1 and recorded based on Design rule for camera file system(16 million colors, 24bit)

### Note:

*Exif is a standard format for audio/image files. Design rule for camera file system is a recording standard for image files. These standards have been established by Japan Electronic Industry Development Association (JEIDA).*

Image quality modes (Image size)      HyPict (1984 × 1488 pixels, 1984 × 744 pixels)  
Super fine (1600 × 1200 pixels, 1600 × 600 pixels)  
Fine (1600 × 1200 pixels, 1600 × 600 pixels)  
Standard (640 × 480 pixels)

Alternative formats

Monochrome, macro, digital ×2 zoom, panorama, continuous shooting, slow flash, and quick shooting

## Optical

Lens      f = 6.5-19.5 mm (equivalent to a 35-105 mm lens on a 35 mm camera)  
F2 (6.5 mm) - F2.8 (19.5 mm)

Focal length      0.5 m to infinity  
0.2 m to 0.5 m (macro mode)

Focus      Auto focus / Manual focus

Sensitivity      Equivalent to ISO 100/200/400

Aperture      f2/f11, 1/3EV steps

Shutter      Electric iris with mechanical shutter 4 to 1/800 seconds

Exposure control      Divided brightness metering program auto, spot metering program auto, and manual exposure adjustment (-2 EV to +2 EV, 9 or 21 steps)

White balance	TTL automatic white balance Fixed (sunlight) User defined
Viewfinder	Real-image optical (view range approx. 90%)
Self timer	Ten seconds
Flash	Built-in automatic luminance control flash (An external flash, which is sold separately, can be attached)
Flash modes	Automatic, forced flash, flash off, red-eye reduction, and leading or trailing slow synchro

#### Built-in flash range

Sensitivity setting	Range (Wide)	Range (Tele)
ISO 100	0.8 - 3.7 m	0.8 - 2.6 m
ISO 200	0.8 - 5.2 m	0.8 - 3.6 m
ISO 400	0.8 - 7.4 m	0.8 - 5.2 m

## Functional

### Photo processing time (approximate)

	Photo processing time	Photo processing time for quick shooting	Photo processing time for replay
Standard	2.0	1.0	0.5
Fine	2.6	1.5	1.0
Super fine	3.2	1.5	1.5
HyPict	12	-	2.0

## Interface





Serial interface 14-pin dual line terminal, RS-232C-compatible special interface for PC, Macintosh  
Communication speed: 19.2 Kbps or higher, max 230 Kbps (for Windows and Macintosh serial cable)  
Max. 12 Mbps (for the USB cable)  
900K bps or 1.8 Mbps (for EPSON printers)

Video out NTSC or PAL

## Power

Sources	DC 1.2 V × 4 (4.8 V) Ni-MH Batteries Model EU-24
	DC 1.5 V × 4 (6.0 V) Alkaline Batteries (IEC LR6)
	DC 7.0 V Optional AC Adapter Model EU-40

Battery life  
(when using four of the included new Ni-MH batteries)

Taking photos with View Finder		1,000 pictures or more
Taking photos with LCD monitor (Automatic shut-off is set to 10 seconds)		Approx. 130 pictures
		Approx. 155 pictures
Playing back photos		Approx. 230 min.
		Approx. 310 min.

## Battery Charger

### Model EU-38

Input	AC 100 - 240V, 50 - 60 Hz
Output	DC 1.2 V 490 mA × 4
Compatible batteries	EPSON Ni-MH Batteries (Model EU-24)
Charging time	Max. 240 min.
Power consumption	8 W
Charging temperature	5 to 35°C
Dimensions	76 × 115 × 28 mm
Weight	Approx. 130 g

## Battery

### Model EU-24

Type name	Cylindrical sealed Nickel-Metal Hydride rechargeable battery
Type	SBA HR6 IEC HR15/51
Size	AA / IEC LR6 compatible
Ratings	DC 1.2 V

Temperature	Charging: 5 to 35°C Storage: -20 to 30°C
Humidity	45 to 85% RH
Weight	Approx. 25 g per cell

---

## **CompactFlash Card**

### **Model ECFB-08**

Storage capacity      8 MB

**Note:**

*For information about the available CompactFlash Card, contact your EPSON dealer.*

Physical Dimensions:

Width	42.8 mm
Height	36.8 mm
Depth	3.3 mm

---

## **Optional PCMCIA Adapter**

Interface	PCMCIA PC Card ATA
Card slot type	Type II
Physical Dimensions:	
Width	54.0 mm
Height	85.6 mm
Depth	5.0 mm

---

## **Optional AC Adapter**

### **Model EU-40**

Input	AC 100 - 240 V, 50 - 60 Hz
Output	DC 7.0 V, 2.0 A
Power Consumption	Max. 0.4 A, 19 W
Physical Dimensions:	
Width	43 mm
Height	31 mm
Depth	104 mm
Weight	Approx. 210 g (Without AC plug)

**A**





### **Contacting Customer Support**

If your camera is not operating properly and you cannot solve the problem using the troubleshooting information in this guide, contact customer support services for assistance.

To help us assist you more quickly, please provide the following information.

**Serial number of your camera**  
(See the label on the bottom of the camera.)

**Camera model**

**Brand and model of your computer**

**EPSON Photo!3 software version**  
(Click About in the Setup menu.)

**Operating System and its version you are using**  
(For example, Windows 95/98 or Mac OS)

**Software applications you normally use with your camera and their version numbers**

**Note:**  
*EPSON recommends making back-ups of your images before sending your camera for repairs. EPSON is not responsible for any lost images.*

---

#### **For United Kingdom and the Republic of Ireland Users**

If you purchased your product in the UK or the Republic of Ireland, EPSON (UK) LTD provides a range of customer services and technical support.

#### **Support Via the World Wide Web**

- For information on the latest EPSON products, software drivers, on-line user guides and answers to frequently asked questions:

<http://www.epson.co.uk>

- ❑ To email EPSON Technical Support:  
<http://www.epson.co.uk/support/email/>
- ❑ For a full list of EPSON Customer and Warranty Support services:  
<http://www.epson.co.uk/support/>

## ***Support Via Telephone***

Our Customer and Warranty Support teams can be contacted by calling 0870 163 7766 in the UK or 0044 0870 163 7766 from the Republic of Ireland. They can provide the following services:

- ❑ Technical information on installing, configuring and operating your EPSON products
- ❑ Arranging for faulty EPSON products to be repaired within the warranty period

Before you call, please have the following information ready:

### **Product Model:**

### **Serial number of your product:**

(The serial number label is on the back of the product)

### **Brand and model of your computer:**

### **Driver software version:**

(Click the About button in your driver)

### **Operating System (for example, Windows 3.1/95/98, NT 3.5/4.0, Mac OS):**

### **Software applications(s) you normally use with your product and their version numbers(s):**

## ***Pre Sales Enquiry Desk***

Our Enquiry Desk team can be contacted by calling 0800 220546 in the UK or 1 800 409132 from the Republic of Ireland, by faxing 01442 227271 in the UK or 0044 1442 227271 from the Republic of Ireland, and via Email at [info@epson.co.uk](mailto:info@epson.co.uk). They can provide the following information:

- ❑ Pre sales information and literature on new EPSON products (also available via our world wide web site at <http://www.epson.co.uk>)
- ❑ Where to purchase genuine EPSON consumables, accessories, and options

---

## ***For Australian Users***

EPSON Australia wishes to provide you with a high level of Customer Service. As well as this *User's Guide*, we provide the following sources for obtaining information.

### ***EPSON FAXBACK***

EPSON FAXBACK will fax you the latest specifications and pricing for most EPSON products offered in Australia. There is also technical information including details of the latest software and drivers available. Phone (02) 9903 9075 and the system will guide you through a number of choices before faxing the information to your fax machine.

### ***EPSON Bulletin Board System***

This is where you can download the latest software and drivers. Visit the BBS to check out the latest versions. If you have a modem, phone (02) 9417 5090.

### ***Internet URL <http://www.epson.com.au>***

Access the Epson Australia World Wide Web pages. Worth taking your modem here for the occasional surf! You can get the same information as offered on the EPSON FAXBACK and the EPSON Bulletin Board plus more.

### ***Your dealer***

Don't forget that your dealer can often help identify and resolve problems. The dealer should always be the first call for advice on problems. They can often solve problems quickly and easily as well as give you advice on the next step to take.

### ***EPSON Helpdesk***

EPSON Helpdesk is provided as a final backup to make sure our clients have access to advice. Operators on the Helpdesk can aid you in diagnosing hardware and software problems. They can also advise you on the latest EPSON products and where the nearest dealer or service agent is located. Many types of queries are answered here.

The Helpdesk numbers are:

Phone: (02) 9903 9040

Fax: (02) 9903 9189

We encourage you to have all the relevant information on hand when you ring. The more information you prepare, the faster we can help solve the problem. This information includes the *User's Guide* for your EPSON product, type of computer, operating system, application programs, and any other information you feel is required.

---

### ***For Singapore Users***

Contact the telephone and fax numbers below.

Phone: (065) 337-7911

Fax: (065) 334-1185

---

### ***For Hong Kong Users***

To obtain technical support as well as other after-sales services, users are welcome to contact EPSON Hong Kong Limited.

### ***Internet home page***

EPSON Hong Kong has established a local home page in both Chinese and English on the Internet to provide users with the following information.

- Product information
- Answers to Frequently Asked Questions (FAQs)
- Latest versions of EPSON camera software

Users can access our World Wide Web home page at: <http://www.epson.com.hk>

## ***Electronic bulletin board system***

An electronic bulletin board system (BBS) is also available to obtain camera information and the latest versions of camera software. You can log on to the following number for the BBS service.

BBS: (852) 2827-4244

## ***Technical Support Hotline***

You can also contact our technical staff at the following telephone and fax numbers.

Phone: (852) 2585-4399

Fax: (852) 2827-4383

---

## ***For Philippines Users***

To obtain technical support as well as other after sales services, users are welcome to contact the EPSON Philippines Representative Office at the telephone and fax numbers below.

Phone: (632) 813-6552

Fax: (632) 813-6545

BBS: (632) 814-0595







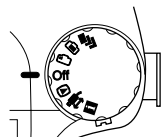

## Dial Position Settings

The PhotoPC 850Z has seven dial positions. This appendix shows the available settings in each dial position. Some dial positions have more than one screen. To change the screen, push Menu Change.

### Dial switch positions



-  For taking multiple exposures.
-  For taking photos with the LCD monitor.
-  For taking pictures with the viewfinder.
- Off** For turning off the camera.
-  For playing back and managing photos.
-  For using EPSON Photo!3, Direct Print, and Print Mark software.
-  For viewing information and setting up the camera.

### Display panel

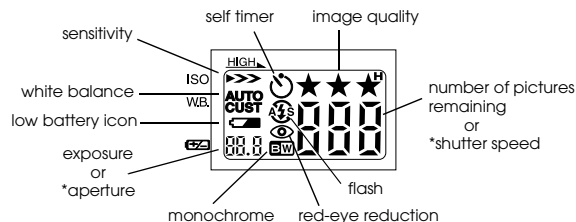

\* When in the Program or Manual camera mode and shutter is pressed half-way.

### Image quality settings

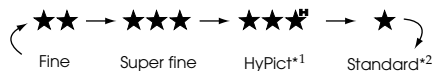

- \*1 Cannot be selected when using the continuous shooting feature.
- \*2 Not available when the monochrome (B/W) is selected.

### Flash settings

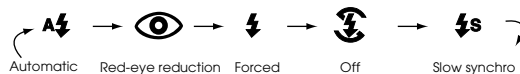

- When using continuous shooting and the external flash, the flash is automatically set to **Off**.
- When in the Full Auto camera mode, or when using the quick shooting function, slow synchro is disabled.

---

## Available settings in the **i** dial position

Set date and time

Change camera mode  
FullAuto, Program, or Manual

Choose Quick Shot or Normal Shot

### Shot SETUP

- Set synchro flash timing (Leading or Trailing)
- Select internal or external flash (INT or EXT)
- Set color or monochrome (Color or B/W)
- Set new white balance setting

### Camera SETUP

- Set automatic shut-off feature  
(10 sec, 30 sec, 1 min, 3 min, or 5 min)
- Set LCD monitor's brightness
- Set speaker volume (Hi or Low)
- Set beep  
(Always, Shutter, or Never)
- Audio recordings  
(3, 5, or 10 sec recording, or Off)



- Set signal system (NTSC or PAL)
- Set language  
(Japanese, English, French, Dutch,  
Italian, Portuguese, Spanish, or Chinese)

### Memory SETUP

- Format
- Select directory
- Copy or delete programs



## Available settings in the dial position

Magnify photos

Delete the photo that appears currently on the LCD monitor

ISO Display multiple photos

W.B. Image Select

Menu Change



Manage audio recordings  
(3, 5, or 10 sec)  
Erase audio recording  
Play back audio recording

View slide show  
Sound Play  
(ON or OFF)  
Change every 3, 5, or 10 seconds, or manually  
Show all photos or selected photos

ISO Display multiple photos

W.B. View photo information

## Available settings in the dial position

### When using the Program camera mode

 Access basic playback functions

 Adjust exposure setting  
From -2.0 to +2.0 by increments of 0.5

Choose frame  
Normal,  Macro,  Panorama, or  
×2 Digital Zoom

ISO Choose sensitivity  
Standard, High, or Super High

W.B. Choose white balance  
AUTO, FIX, or CUSTOM



Choose Program camera mode setting  
Normal, Sports, Portrait, or Landscape

## When using the Manual camera mode

Make advanced exposure adjustments  
Auto Exposure, Shutter Priority,  
Aperture Priority, or Manual Exposure

 Auto Exposure, Shutter Priority, and Aperture Priority:  
Choose exposure adjustment  
From -2.0 to +2.0 in increments of 0.2

Manual Exposure:  
Choose shutter speed  
From 4 to 1/800 seconds





Choose frame  
Normal,  Macro,  Panorama, or  
x2 Digital Zoom



ISO Shutter Priority:  
W.B. Choose shutter speed  
From 4 to 1/800 seconds

Aperture Priority and Manual Exposure:  
Choose aperture  
Wide: f2, f2.8, f4, f5.6, f8, or f11  
Tele: f2.8, f4, f5.6, f8, or f11

Menu Change

 Access basic playback functions

 Choose focus settings  
For Normal, Panorama frame, and digital zoom  
AF (auto focus),  (about 0.8 m),  
 (about 2.5 m), or  ( $\infty$ )  
For Macro frame  
AF (auto focus), or MACRO1 (about 20 cm) to MACRO2 (about 50 cm)

Choose metering system  
 divided brightness metering system, or  spot metering system

ISO Choose sensitivity setting  
Standard, High, or Super High

W.B. Choose white balance  
AUTO, FIX, or CUSTOM

---

# Glossary

## ***application***

A software program that helps you carry out a particular task, such as word processing, image editing, or financial planning.

## ***bit***

Short for binary digit. The smallest unit of data in computer processing. A bit can represent two values: on and off, or 1 and 0.

## ***browser (Web browser)***

An application which allows the users to view HTML documents.

## ***default***

A value or setting that takes effect when the equipment is turned on, reset, or initialized. Also known as a factory setting.

## ***Design rule for camera file system***

Recording standard for image files. Established by Japan Electronic Industry Development Association (JEIDA).

## ***Exif2.1***

Standard format for audio/image files. Established by Japan Electronic Industry Development Association (JEIDA).

## ***exposure***

The amount of light the camera captures when a photo is taken.

## ***Image***

Data representing a two-dimensional scene. A digital image is composed of pixels arranged in a rectangular array with a certain height and width. Each pixel may consist of one or more bits of information, representing the brightness of the image at that point.

## ***ink jet printer***

A printer that transfers ink onto paper by spraying the ink through a number of small nozzles.

## ***interface***

A piece of hardware, a method, or a standard used for connection between the computer and the camera.

## ***macro***

An enlargement or a close-up of an image.

## ***NTSC***

National Television Standards Committee. A video encoding standard largely used in North America and Japan.

## ***PAL***

Phase Alternation Line. A video encoding standard largely used in Europe and Australia.

## ***pixel***

Short for picture element. Each image is composed of a number of pixels. Pixels are also counted in units of dots.

***port***

An interface channel through which data is transmitted between devices.

***resolution***

Indication of how finely an image is resolved into pixels. See *pixel*.

***thumbnails***

Small representations of images.

***white balance***

The balance between the whiteness and color in your image. When the white balance is fixed to the environment where the picture is taken, the colors in your images appear more like those seen by the eye.

***zoom***

To show a smaller area of an image at a higher magnification (zoom in) or a larger area at a lower magnification (zoom out).

---

# Index

## Symbols

- button, 1-2
- + button, 1-2

## A

- AC adapter, 2
  - connector, 1-2
  - specifications, A-5
  - using, 6-5 to 6-6
- Accessory lens, 6-7
- AC power cord, 1-1
- Activating the shutter, 2-5, 2-12
- Aperture priority, 2-21
- Attaching the strap, 1-10
- Audio recordings, 2-2, 2-3, 2-25 to 2-27, 2-30, 3-1, 3-8, 6-2, 6-3
- Auto exposure, 2-20
- Automatic flash, 2-9
- Automatic shut-off feature, 2-30 to 2-31
- AV connector, 1-2

## B

- Backlight switch, 1-2, 2-12
- Basic playback feature, 2-13
- Batteries
  - charging, 1-5 to 1-6
  - checking, 1-7, 1-8
  - disposing of, 1-9

- handling, 1-8
- icon, 1-3
- installing, 1-6
- replacing, 1-8
- specifications, A-4
- storing, 1-9

- Battery charger, 2, 1-1
  - cleaning, 7-2
  - specifications, A-4
  - using, 1-5 to 1-6
- Beep, 2-6, 2-12, 2-31
- Brightness, LCD monitor, 2-31
- Buttons, 1-2 to 1-3

## C

- Cables
  - AV, 1-1
  - for direct printing, 4-2
  - Macintosh serial, 1-1
  - USB, 1-1
  - Windows serial, 1-1
- Camera
  - buttons, 1-2 to 1-3
  - cleaning, 7-2
  - connecting to a projector, 3-11
  - connecting to a television, 3-9
  - handling, 7-1
  - parts, 1-2 to 1-4

- physical dimensions, A-1
- problems, 7-3 to 7-7
- storing, 7-2
- Camera case, 1-1
- Camera modes, 2-28 to 2-29
  - changing, 2-29
  - Full Auto, 2-28
  - Manual, 2-16, 2-29
  - Program, 2-16, 2-28
- Checking
  - batteries, 1-7, 1-8
  - picture counter, 2-2, 7-3, 7-6
- Cleaning
  - battery charger, 7-2
  - camera, 7-2
- Color / monochrome setting, 2-33
- Color Guide, 2-34
- CompactFlash, 1-1
- CompactFlash Card, 2-34
  - copying photos, 6-3
  - copying programs, 6-3
  - formatting, 6-4
  - installing, 1-10 to 1-11
  - installing into the computer, 6-2
  - removing, 1-11
  - selecting the folder, 2-34
  - specifications, A-5
  - storage capacity, 6-1
- Continuous shooting, 2-23
- Copying photos, 6-3
- Copying programs, 6-3
- Covers
  - battery, 1-3

- memory card, 1-2
- skylight, 2-12
- Customer support, B-1 to B-5

## **D**

- Date and time setting, 1-12
- Dial switch, 1-2, 1-3
  - available settings, C-2 to C-4
  - LCD monitor, 2-11 to 2-23
  - positions, 2-3 to 2-4, C-1
  - viewfinder, 2-5 to 2-11
- Dial switch lock, 1-2
- Digital zoom, 2-13
- Diopter correction, 1-2, 2-5
- Direct Print
  - accessing the program, 4-4
  - connecting the camera to the printer, 4-3
  - deleting the program, 4-4, 6-3
  - installing the program, 4-4, 6-3
  - messages, 5-7 to 5-8
  - printed image dimensions, 4-11 to 4-12
  - printing procedures, 4-7 to 4-9
  - status messages, 4-10 to 4-11
  - supported paper types, 4-2
  - supported printers, 4-2
- Display panel, 1-2
  - camera, icons, 1-3
  - printer, messages, 4-11
- Disposing of batteries, 1-9
- Divided brightness metering system, 2-22
- DPOF file, 5-1

## **E**

EPSON Photo File Format, 3-1

Erasing

- all the photos, 3-6
- audio recordings, 3-8
- individual photos, 3-5
- selected photos, 3-6

Exposure

- adjusting the setting, 2-11, 2-18 to 2-21
- aperture priority, 2-21
- auto, 2-20
- changing the predefined settings, 2-15 to 2-16
- manual, 2-21
- shutter priority, 2-20

External flash

- attachment, 1-2
- installing, 2-32
- selecting, 2-32

## **F**

Fine, 2-8

Flash, 1-2

- button, 1-3
- range, A-3
- selecting the internal or external, 2-32
- settings, 2-9

Forced flash, 2-9

Formatting memory cards, 6-4

Full Auto camera mode, 2-28

## **H**

Hot shoe, 1-2

HyPict, 2-8

## **I**

Icons

- divided brightness metering system, 2-22
- flash, 1-3
- image quality, 1-3
- low battery, 1-3, 1-7
- monochrome, 1-3
- red-eye reduction, 1-3
- self timer, 1-3
- sensitivity, 1-3
- spot metering system, 2-23

Image quality

- button, 1-3
- setting, 2-7 to 2-8

Indication

- aperture, 1-3
- checking the display panel, 2-2
- exposure, 1-3
- pictures remaining, 1-3
- shutter speed, 1-3
- white balance, 1-3

Installing

- batteries, 1-6
- CompactFlash Card, 1-10 to 1-11

Interface connector, 1-2

Interface specifications, A-3

Internal flash, 2-32

ISO button, 1-2

## **L**

- Languages, 1-11, 2-34
- LCD monitor, 1-2, 2-31
  - messages, 4-10, 4-11
- Lens, 1-2
  - accessory, 6-7
  - adapter, 6-7
- Lens adapter, 1-1, 6-7
- Lights
  - shooting, 1-2, 1-4, 2-5, 2-6, 4-9
  - status, 1-2, 1-4, 2-6, 2-12
  - timer, 1-2, 2-7
- Lock
  - battery cover, 1-3
  - dial switch, 1-3
- Locking photos, 3-7 to 3-8

## **M**

- Macro feature, 2-14
- Maintenance, 7-1 to 7-2
- Manual camera mode, 2-16, 2-29
- Manual exposure, 2-21
- Manual focus setting, 2-21
- Memory card
  - See CompactFlash Card
- MENU button, 1-2
- Messages
  - camera's LCD monitor, 4-10 to 4-11
  - printer's display panel, 4-11
- Metering system setting, 2-22
- Microphone, 1-2
- Monochrome/color setting, 2-33

- Multi-photo playback, 3-1 to 3-2

## **N**

- Ni-MH rechargeable batteries, 2, 1-1
- NTSC, 2-34

## **O**

- Optical specifications, A-2
- Optical zoom, 2-6
- Options, 2 to 3
  - AC adapter, 6-5 to 6-6, A-5
  - PCMCIA adapter, 6-2, A-5

## **P**

- PAL, 2-34
- Panoramas, 2-14
- PCMCIA adapter, 2
  - specifications, A-5
  - using, 6-2
- Photographs
  - See Pictures
- Photo information, 3-1, 3-5
- Photo processing time, A-3
- Physical dimensions, A-1
- Picture counter, 2-2
- Pictures
  - close-ups, 2-14
  - copying, 6-3
  - erasing, 3-5 to 3-7
  - locking, 3-7 to 3-8
  - memory storage capacity, 2-8



- printing using the Direct Print program, 4-1 to 4-9
  - printing using the Print Mark program, 5-1 to 5-8
  - problems, 7-7 to 7-9
  - processing time, A-3
  - recorded image specifications, A-2
  - shooting range, 2-1
  - taking with the LCD monitor, 2-11 to 2-13
  - taking with the viewfinder, 2-5 to 2-6
  - unlocking, 3-7 to 3-8
  - Playing back audio recordings
    - on a television, 3-9
    - with the built-in speaker, 2-27
  - Playing back photos
    - multiple photos at once, 3-1 to 3-2
    - on a projector, 3-11
    - on a television, 3-9
    - on the LCD monitor, 3-1 to 3-5
    - using the magnification feature, 3-2
    - when taking photos with the LCD monitor, 2-13
  - Power specifications, A-4
  - Printed image dimensions, 4-11 to 4-12
  - Printer's display panel messages, 4-11
  - Printing pictures
    - using the Direct Print program, 4-1 to 4-12
    - using the Print Mark program, 5-1 to 5-8
  - Print Mark
    - changing the DPOF file, 5-6
    - confirming the DPOF file, 5-6
    - deleting the DPOF file, 5-7
    - deleting the program, 5-2, 6-3
    - DPOF file, 5-1
    - installing the program, 5-2, 6-3
    - making the DPOF file, 5-2
    - printing an index of photos, 5-4 to 5-5
    - printing photos in a standard layout, 5-2 to 5-4
  - Problems
    - camera, 7-3 to 7-7
    - picture, 7-7 to 7-9
  - Program camera mode, 2-16, 2-28
  - Projector connected to the camera, 3-11
- Q**
- Quick shooting feature, 2-29
- R**
- Rechargeable batteries, 2, 1-1
  - Recording audio
    - for existing photos, 2-26
  - Red-eye reduction, 2-9
  - Removing CompactFlash Card, 1-11
  - Replacing batteries, 1-8
  - Rotating pictures
    - printing, 4-6, 4-8
    - slide show, 3-4
- S**
- Safety instructions
    - when using strap, 4
    - when using the camera, 3 to 4
    - when using the charger and batteries, 4 to 6
  - Self timer, 2-6 to 2-7
    - button, 1-3
    - light, 1-2
  - Sensitivity setting, 2-10, 2-17 to 2-18

## Settings

- adjusting the exposure, 2-11, 2-18 to 2-21
- automatic shut-off feature, 2-30 to 2-31
- available in Full Auto camera mode, 2-28
- available in Manual camera mode, 2-16, 2-29
- available in Program camera mode, 2-16, 2-28
- beep, 2-31
- changing the predefined exposure, 2-15 to 2-16
- color/monochrome, 2-33
- custom white balance, 2-33
- date and time, 1-12
- exposure, 2-11, 2-15 to 2-16, 2-18 to 2-21
- flash, 2-9
- image quality, 2-7 to 2-8
- internal or external flash, 2-32
- language, 1-11, 2-34
- LCD monitor brightness, 2-31
- manual focus, 2-21
- metering system, 2-22
- sensitivity, 2-10, 2-17 to 2-18
- signal system, 2-34
- speaker volume, 2-31
- time and date, 2-27
  - white balance, 2-10, 2-16 to 2-17
- Shooting light, 1-2, 1-4, 2-5, 2-6, 4-9
- Shut-off feature, 2-30 to 2-31
- Shutter button
  - location, 1-2, 1-3
  - using, 2-5
- Shutter priority, 2-20
- Signal system, 2-34
- Sky light, 1-2
- Skylight, 2-12

- Slide show, 3-3 to 3-4

- Slow synchro
  - selecting the timing, 2-32
  - using, 2-9

- Speaker Back view, 1-2

- Speaker volume, 2-31

## Specifications

- AC adapter, A-5
- battery, A-4
- battery charger, A-4
- camera, A-1 to A-4
- CompactFlash Card, A-5
  - optical, A-2
- PCMCIA adapter, A-5

- Spot metering system, 2-23

- Standard image quality, 2-8

- Status light, 1-2, 1-4, 2-6

- Status light Shutter button

- using, 2-12

- Status messages for direct printing, 4-10 to 4-11

- Storage capacity

- CompactFlash Card, 6-1

- Storing

- the batteries, 1-9

- the camera, 7-2

- Strap, 1-1

- attaching, 1-10

- eyelet, 1-2

- Super fine, 2-8

## **T**

- Taking panoramas, 2-14
- Taking pictures
  - continuously, 2-23
  - using quick shooting feature, 2-29
  - using self timer, 2-6 to 2-7
  - using the digital zoom feature, 2-13
  - using the macro feature, 2-14
  - using the optical zoom feature, 2-6
  - using time lapse function, 2-24
- Taking pictures with the LCD monitor, 2-11 to 2-13
- Taking pictures with the viewfinder, 2-5 to 2-6
- Tele, 2-6
- Television connected to the camera, 3-9
- Time and date setting, 2-27
- Time lapse function, 2-24
- Timer light, 1-2
- Tripod socket, 1-3
- Troubleshooting, 7-3 to 7-9

## **U**

- Unlocking photos, 3-7 to 3-8
- Unpacking your camera, 1-1

## **V**

- Viewfinder, 1-2
  - using, 2-5 to 2-7
- Viewing slide show, 3-3

## **W**

- W.B.button, 1-2
- White balance
  - adjusting the setting, 2-10, 2-16 to 2-17
  - making the custom setting, 2-33
  - when to adjust, 2-16
- Wide, 2-6

## **Z**

- Zoom
  - digital, 2-13
  - lever, 1-2, 1-3, 2-6
  - optical, 2-6



## EPSON OVERSEAS MARKETING LOCATIONS

---

**EPSON AMERICA, INC.**

20770 Madrona Ave.  
P.O. Box 2842  
Torrance, CA 90509-2842  
Phone: (800) 922-8911  
Fax: (310) 782-5220

**EPSON UK LTD.**

Campus 100, Maylands Avenue,  
Hemel Hempstead, Herts,  
HP2 7TJ, U.K.  
Phone: (+44) 01442 261144  
Fax: (+44) 01442 227227

**EPSON DEUTSCHLAND GmbH**

Zülpicher Straße 6,  
40549 Düsseldorf Germany  
Phone: (0211) 56030  
Fax: (0211) 5047787

**EPSON FRANCE S.A.**

68 bis, rue Marjolin  
92300, Levallois-Perret, France  
Phone: 33.1.40.87.37.37  
Telex: 610657

---

**EPSON AUSTRALIA PTY.  
LTD.**

70 GIBBES STREET,  
CHATSWOOD 2067 NSW.  
Phone: 2-9903-9000  
Fax: 2-9903-9177

**EPSON SINGAPORE PTE. LTD.**

No. 1 Temasek Avenue #36-00  
Millenia Tower, Singapore 039192  
Phone: (065) 33 77 911  
Fax: (065) 33 41 185

**EPSON HONG KONG LTD.**

Rooms 4706-10, 47/F,  
China Resources Bldg.,  
26 Harbour Road, Wanchai,  
Hong Kong  
Phone: 2585-4300  
Fax: 2827-7083

**EPSON TAIWAN TECHNOLOGY &  
TRADING LTD.**

10F, No. 287 Nanking E. Road, Sec. 3,  
Taipei, Taiwan, R.O.C.  
Phone: (02) 717-7360  
Fax: (02) 712-9164

---

**EPSON ITALIA S.p.A.**

V.le F.lli Casiraghi 427  
20099 Sesto S.Giovanni  
MI, Italy  
Phone: 2-262331  
Fax: 2-2440750

**EPSON IBERICA S.A.**

Av. de Roma, 18-26  
08290 Cerdanyola del Valles  
Barcelona, Spain  
Phone: 582. 15.00  
Fax: 582. 15.55

**EPSON PORTUGAL, S.A.**

R. do Progresso, 471, 1ª Perafita  
4460 Matosinhos, Portugal  
Phone: (02) 996 14 02  
Fax: (02) 996 14 11

**SEIKO EPSON CORPORATION  
(Hirooka Office)**

80 Harashinden, Hirooka  
Shiojiri-shi, Nagano-ken  
399-0785 Japan

**EPSON**

Color Digital Camera



**PhotoPC**<sub>850Z</sub>

*User's Guide*